

EMM[®]

TANK 2 Pro CNC key cutting machine manual

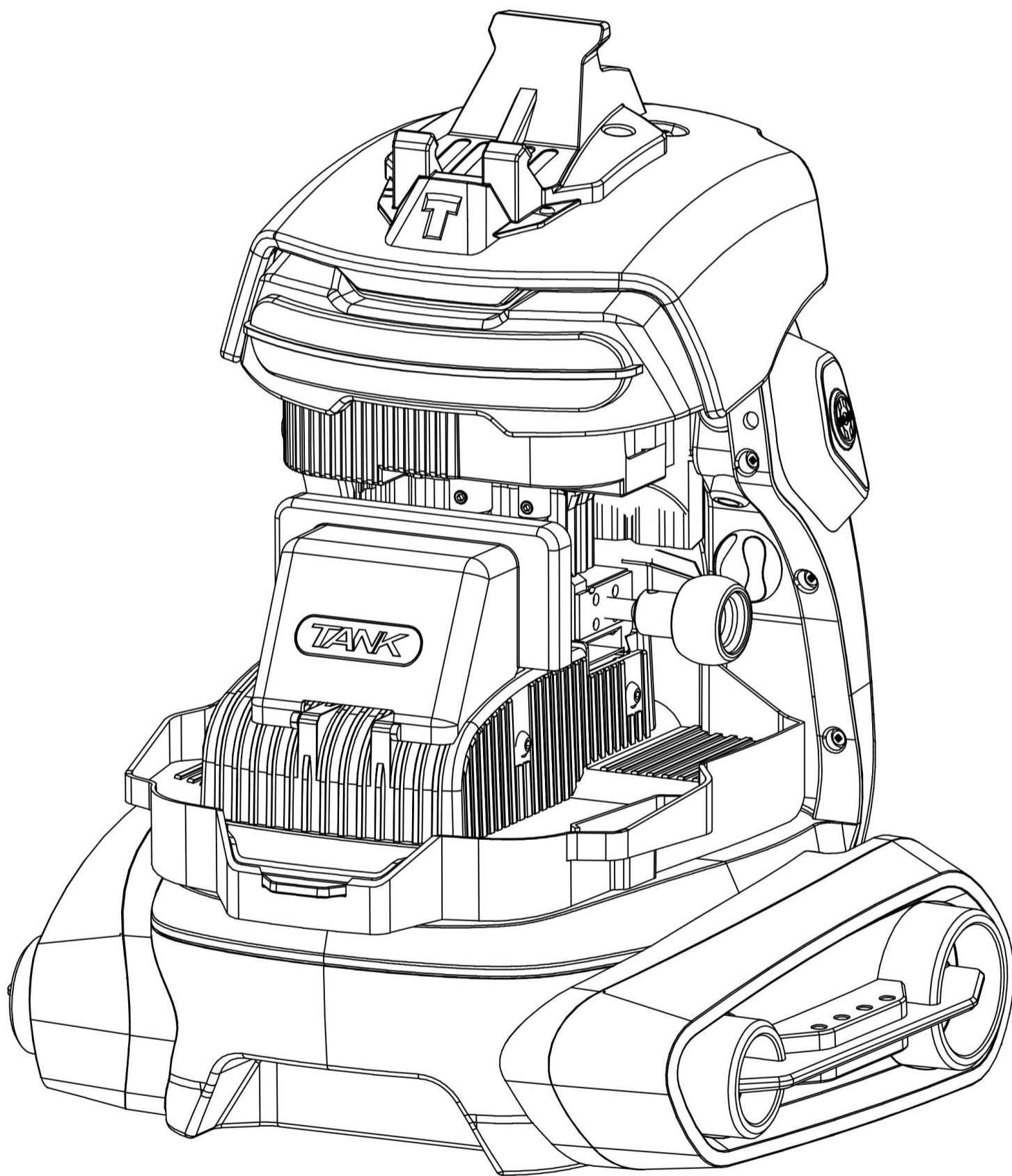

Table of contents

1、 Safety precautions and warnings	
1-1 Power supply precautions	04
1-2 Installation precautions	04
1-3 User precautions	04
1-4 Other precautions	04
2、 General information	
2-1 Machine description	05
2-2 Machine characteristics	05
3、 Product packaging checklist	06
4、 Overview	
4-1 Structure diagram	07
4-2 Specification	08
4-3 Software overview	10
4-3-1 Introduction	11
4-3-2 Smart phone operation system	11
4-3-3 Software update	11
5、 Installation instruction	
5-1 Cutter and probe installation	12
5-2 Cutter and probe uninstallation	13
5-3 Clamp installation	14
5-4 Standard clamp guide	15
5-5 clamp range	16
6、 Operation instructions on APP	
6-1 How to download the Tank APP	17
6-2 How do new users sign up ?.....	17
6-3 Bluetooth connection	18
6-4 Height level adjustment	19
6-5 Clamp calibration	20
6-6 Cutting calibration	21
7、 How to use ‘Key database’	23
8、 How to use ‘All key lost’	24
9、 How to use ‘Find biting’	25

10、 How to use ‘Universal key duplicate’	26
11、 How to generate key blank?	28
11-1 How to use ‘generate key type’ ?	28
11-2 How to customize key blank?	29
12、 DIY key	31
13、 2 in 1 decoder	
13-1、 Hu162T-9 cuts.....	33
13-2、 Hu162T-10 cuts.....	36
13-3、 TOY43.....	39
14、 Updating online	
14-1 APP update	40
14-2 Update key database	41
14-3 Firmware update	41
15、 Maintenance	42
16、 Warranty	42
17、 contact us by WhatsApp	43

1、 Safety precautions and warnings

To avoid injuries to operators, please read this product user manual carefully Before you start and follow the safety notes listed below

1-1 Power supply precautions

- Do not use damaged wires or loose socket
- Do not plug more devices at the same socket
- Do not pull wire or touch the metal part of power supply
- Unplug the machine when it is not in use for a long time
- If any problem happens, please contact technique support

1-2 Installation precautions

- Do not place the machine in a place that is damp, greasy and dusty
- Do not put things like candle or cigarette end on the machine
- Always use the machine under safe environment
- Put the machine on the stable platform

1-3 User precautions

- Do not have clothes, hair, hands and other tools close to the machine when it is working
- Do not put things like tool or container on the machine

1-4 Other precautions

- Do not disassemble the machine if you don' t get permission from factory technique support.
- Keep the children away from the machine when it is working

2、 General information

2-1 Machine description

Dear customer, thank you for using 2M2 tank automatic key cutting machine, it is a portable and light weight, especially designed for locksmiths in the world to work outdoor. To avoid injuries and damages to the machine, please use the machine correctly according to product user manual. Please read the manual carefully before you start to use the machine.

2-2 Machine characteristics

- Smart control and operation on APP and build-in database
- Portability and build-in Lithium battery with a long battery life (optional)
- Equipped with B clamp (standard clamp), F021 clamp
- Cutter and probe work in parallel
- Aluminum structure
- Imported ball screw with high precision
- Cross rail with high rigidity
- Supporting free online update
- Operating in multiple languages (Currently available in English, Spanish, Portuguese, Farsi, German, French, Hebrew, Hindi, Indonesian, Italian, Korean, Polish, Russian, Vietnamese, Japanese and other languages)













3、Product packaging checklist

PACKING LIST

TANK
April 2024

TANK 2 Pro



Accessories			
			
1.5 cutter*1pcs 2.0 cutter*1pcs	Probe*3pcs	Power adapter Power cord	4.0mm hexagon bar wrench
			
XYZ sensor	Belt for motor*4pcs	Screw x2	2.0mm hexagon bar wrench
			
2.5mm hexagon bar wrench	Blow	Brush	Stopper
			
S#*3pcs	L#*3pcs	T#*3pcs	HON66#*1pcs
			
Screw Pressing tool			



Accessories box



Packaged

4、 Overview

4-1 Structure



ACCESSORIES & PARTS



TANK II Pro

TANK 2 PRO



4-2 Specification

Input voltage	100-250V AC
Input frequency	50-60Hz
Power	144W
Power parameter	24V DC/6A
Battery capacity (optional)	65Wh
Principal axis rotation speed	10000rpm
Working temperature	-20°C-50°C
Humidity	10-90%
Gross weight	13KG
Net weight	16.5KG
Machine size	36cm*27cm*41cm
Package size	43.5cm*35.5cm*46.5cm

4-3 Software overview

4-3-1 Introduction

- Supporting self-calibration
- Supporting key duplication and cutting for vehicle/motorcycle/household keys
- Supporting universal key decode for multiple key types
- Operation on APP through Bluetooth
- Build-in key database

4-3-2 Smart phone operation system

- Android: Android 5.0 and above version
- IOS: IOS 12.0 and above version

4-3-3 Software update

- Online update on APP
- Update via upgrade suite

5、 Installation instruction

5-1 Cutter and probe installation

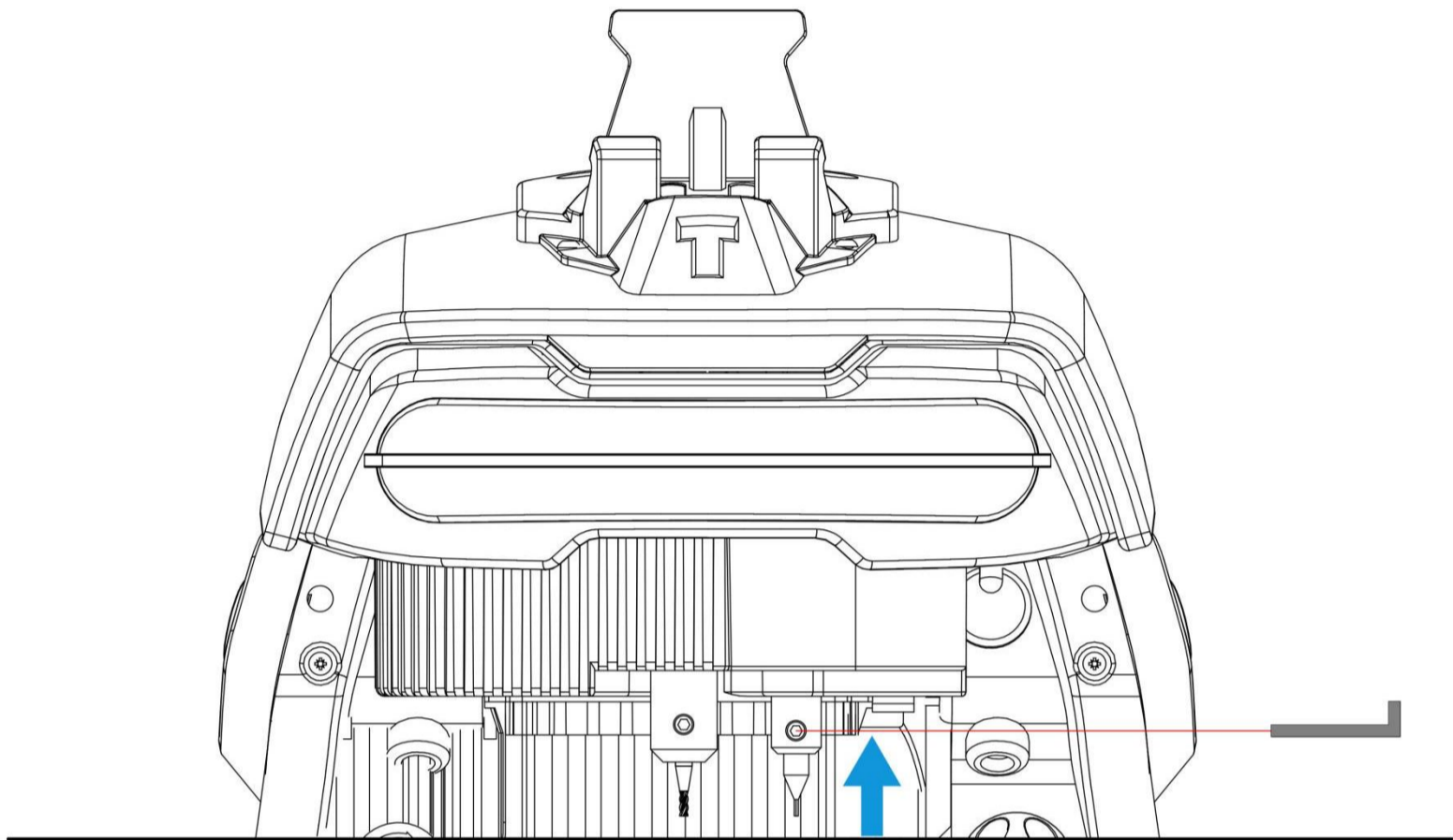

Installation steps:

Insert cutter and probe onto the top depend on the arrow, and then use 2.5mm hexagon bar wrench to lock the screw.

Notes: when pushing both cutter and probe onto the top, probe Height is higher than cutter height.

5-2 Cutter and probe installation

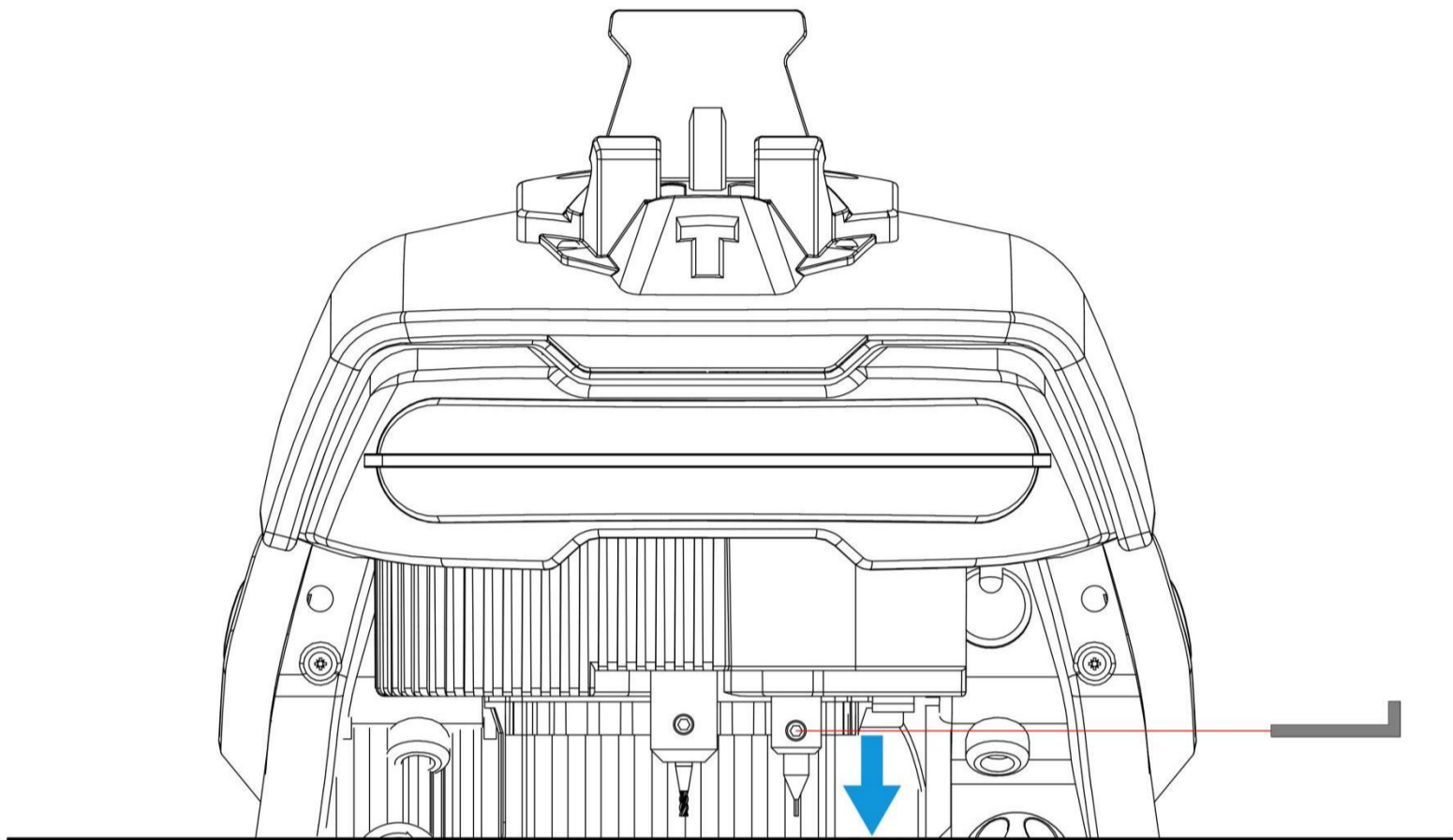

Installation steps:

Use 2.5mm hexagon bar wrench to unscrew the locks for cutter and probe until they are loosened off.

5-3 Clamp installation

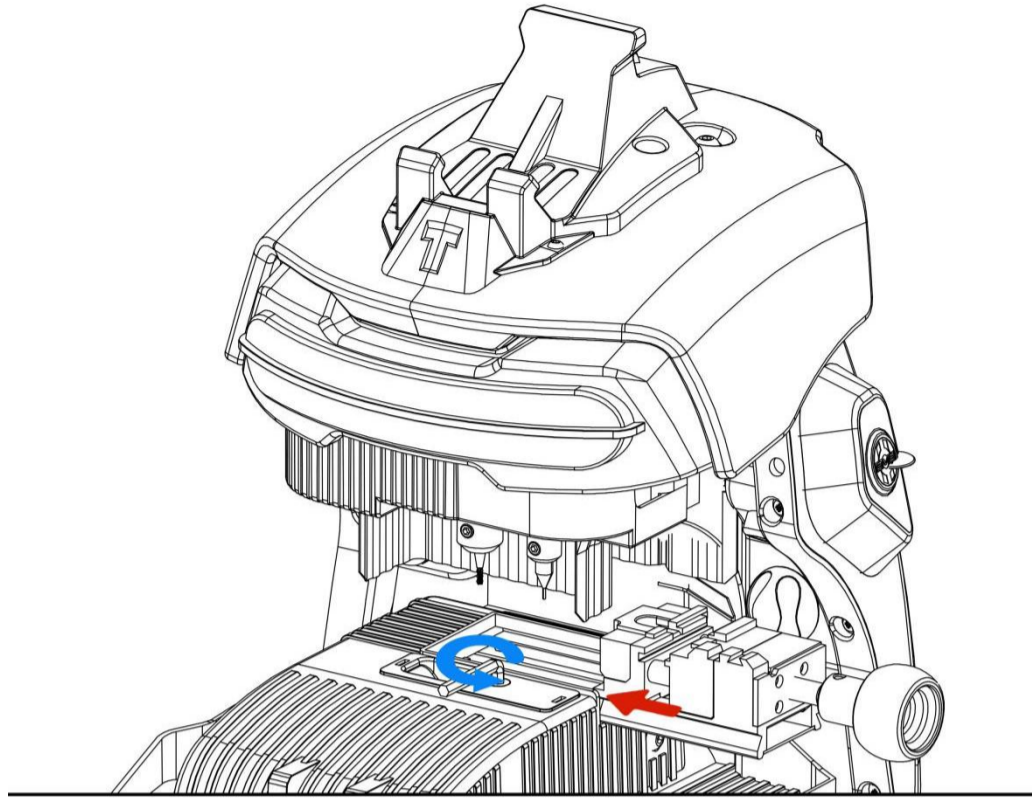

Picture 1

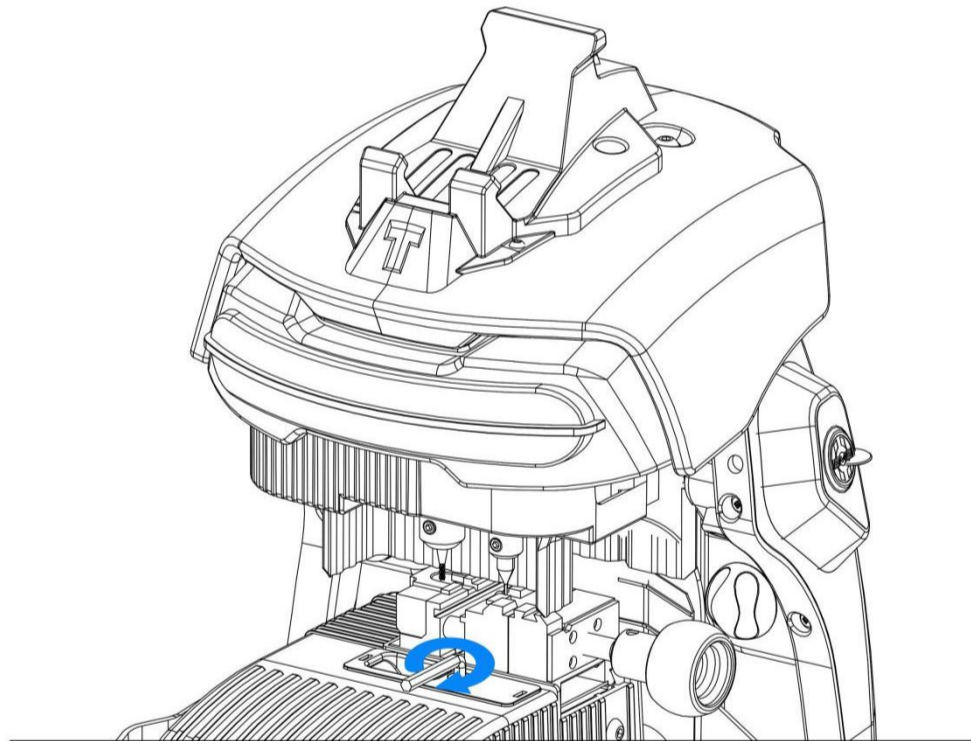

Picture 2

Installation steps:

Unscrew the lock for the clamp, insert the clamp along the rail depend on the arrow (picture 1). and then use 4mm hexagon bar wrench to screw the lock (picture 2).

5-4 Pictures of clamp

B Clamp

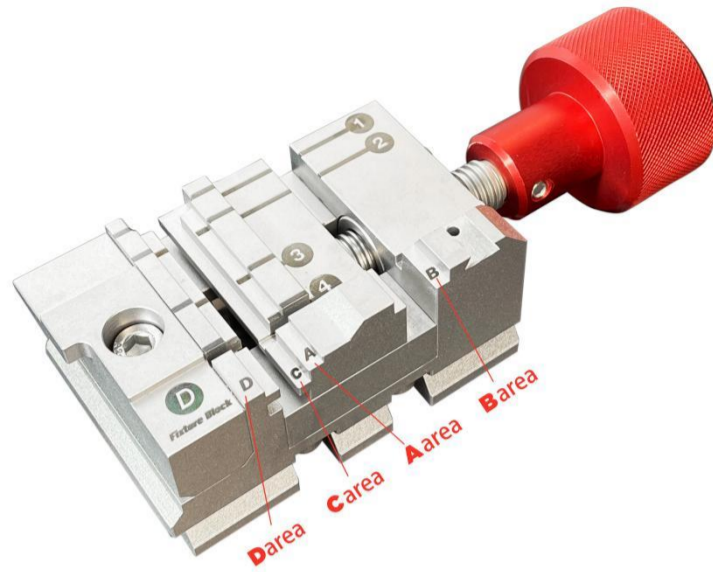

Supporting types



Single sided key

Double sided key

2 Track external

Residential



4 Track external

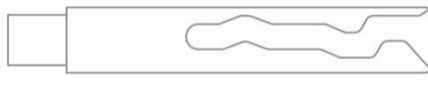

Channel track



4 Track internal



SX9

F Clamp (F021/TBE1)





Supporting types

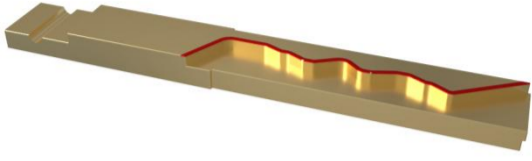
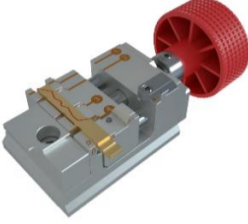
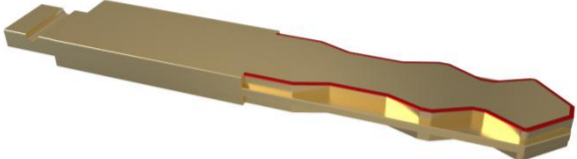
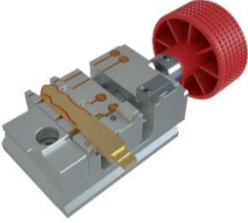
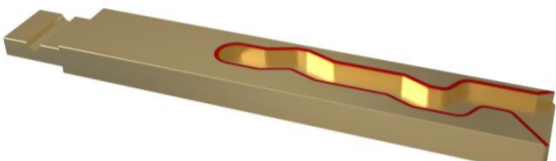
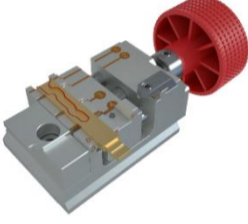
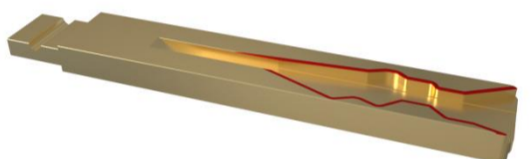
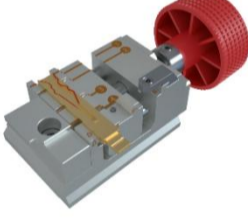
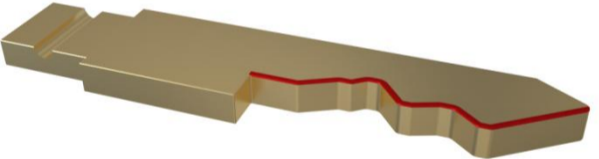
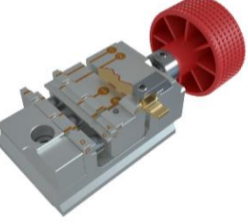
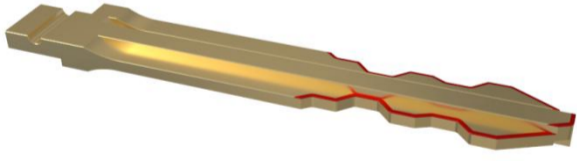
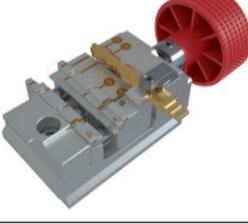
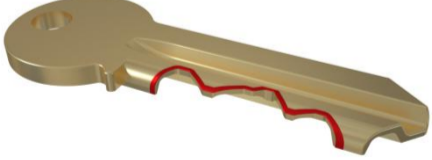
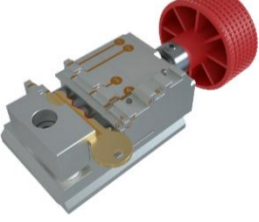
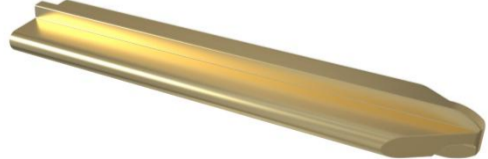
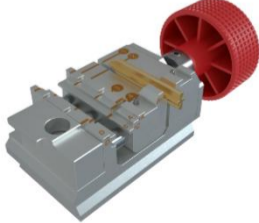

F021/TBE1

5-5 Standard clamp B range

Key types	Cutting side pictures	Clamp cutting sides	Description
2 track external			Clamp B A area
4 Track external			Clamp B A area
Channel track			Clamp B A area
4 Track internal			Clamp B A area
Single sided key			Clamp B B area
Double sided key			Clamp B B area
Residential key			Clamp B D area
SX9			Clamp B B area
FO21/TBE1			Clamp F

6、 Operation instructions on APP

6-1、 How to download the Tank APP?

Web: <https://downloadapp.magicxtank.com/#/>

Android:

IOS:



Scan QR code for Android

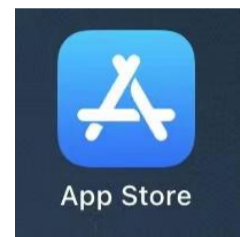

Search bar containing the text "magictank"



Search ' MagicTank ' in App Store for iPhone

6-2、 How do new users sign up ?

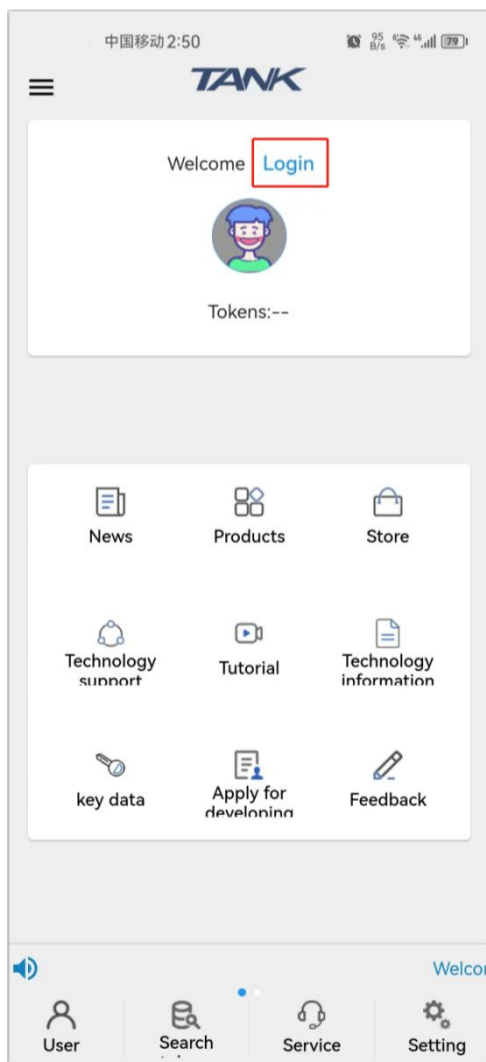

Please register

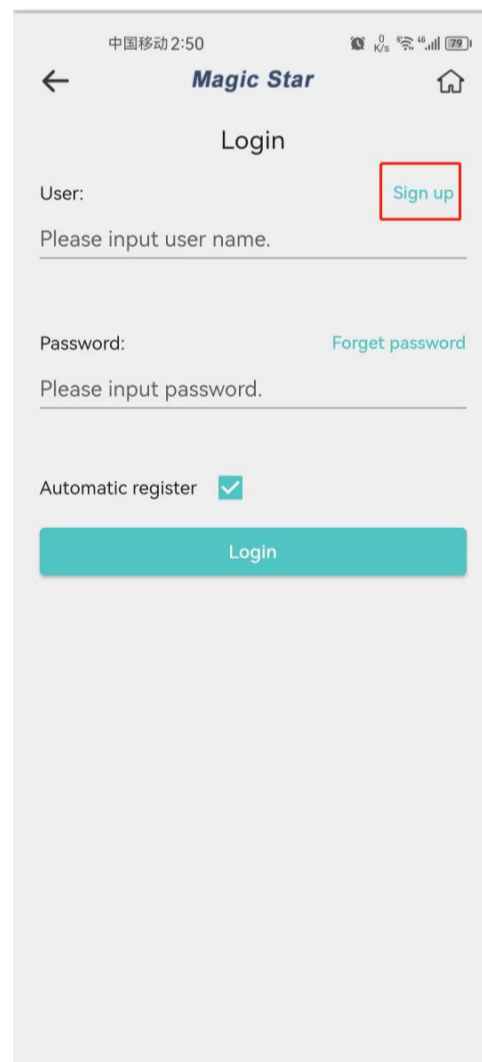

Please sign up via phone number.

6-3、 Bluetooth connection

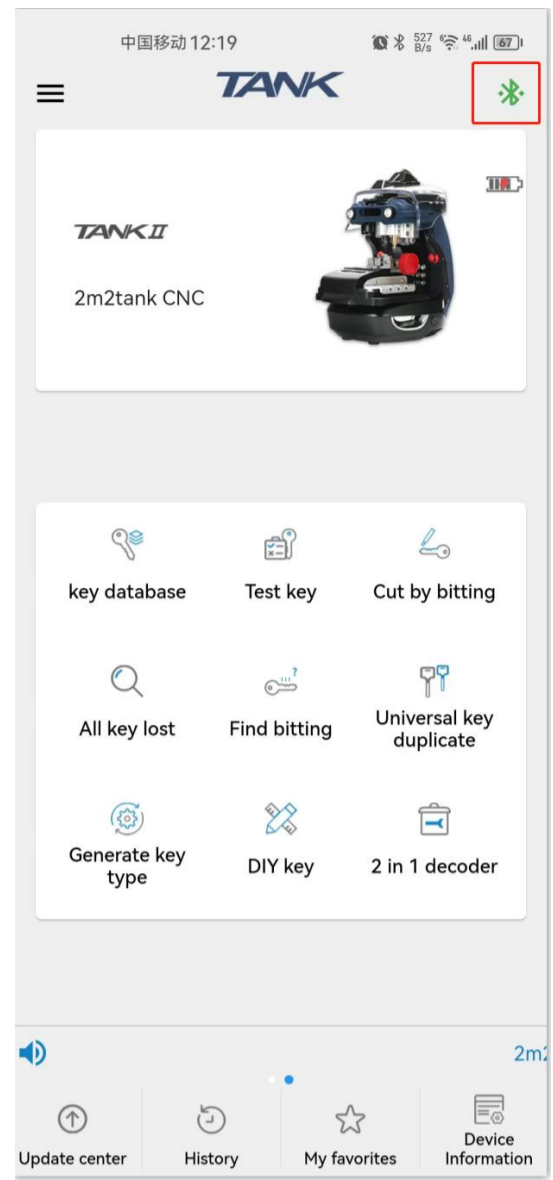
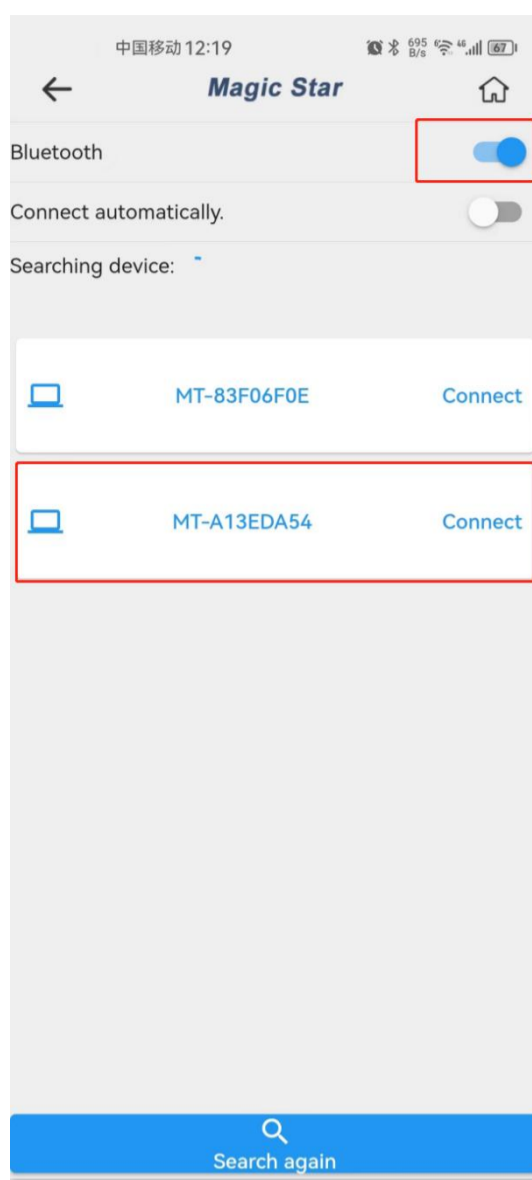
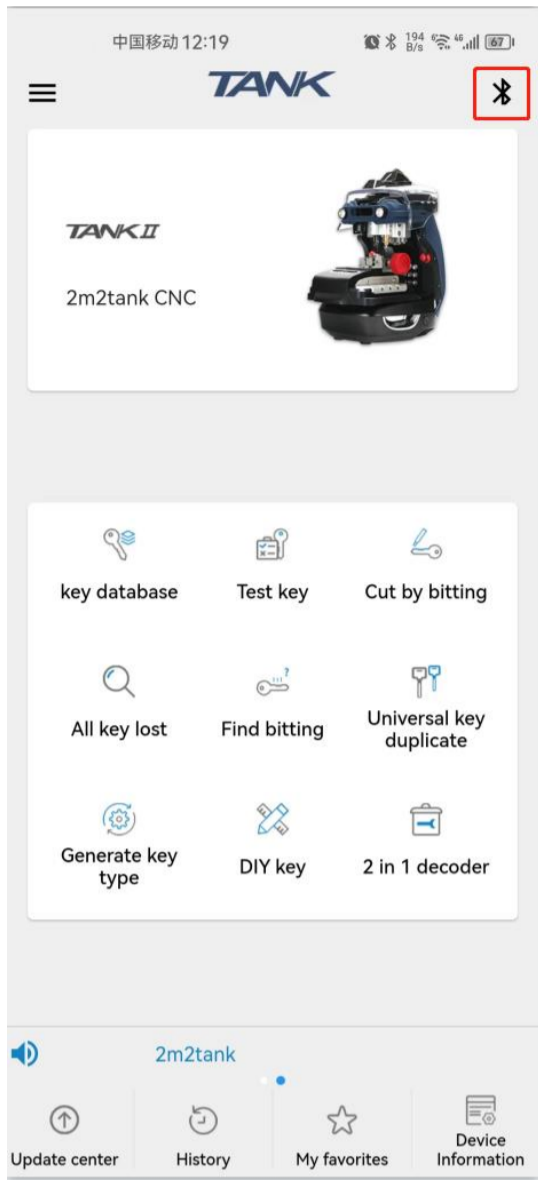

Click bluetooth logo, Click bluetooth switch and then click series number, Connection is ok.

6-4、 Height level adjustment

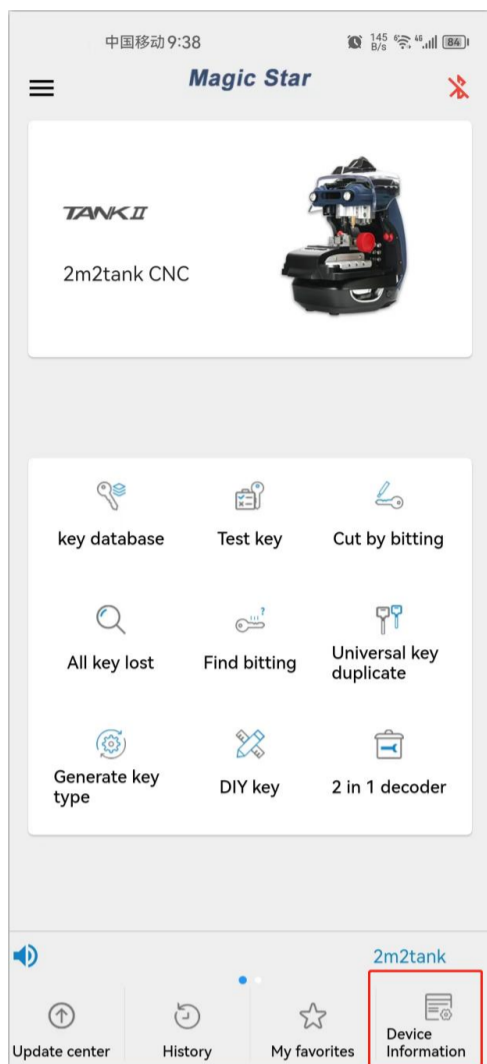

Enter 2M2TANK APP and click 'Device information', Click 'change cutter & probe',

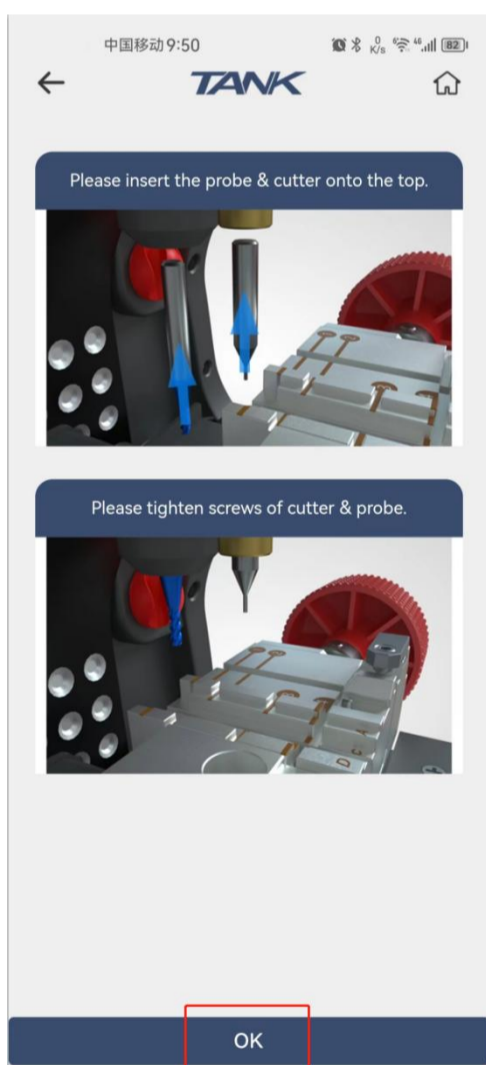

Installation and then click "OK"

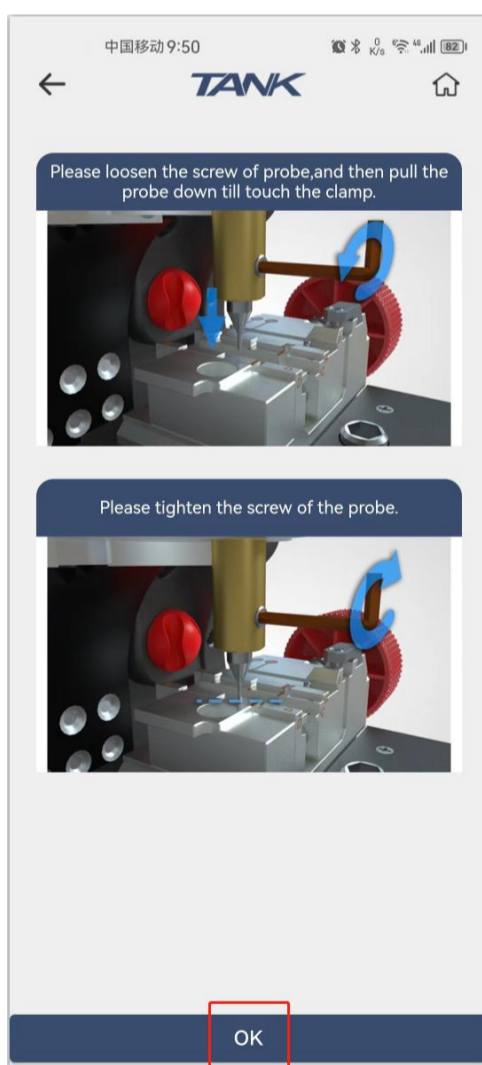

Loosen off the screw until it touches the clamp

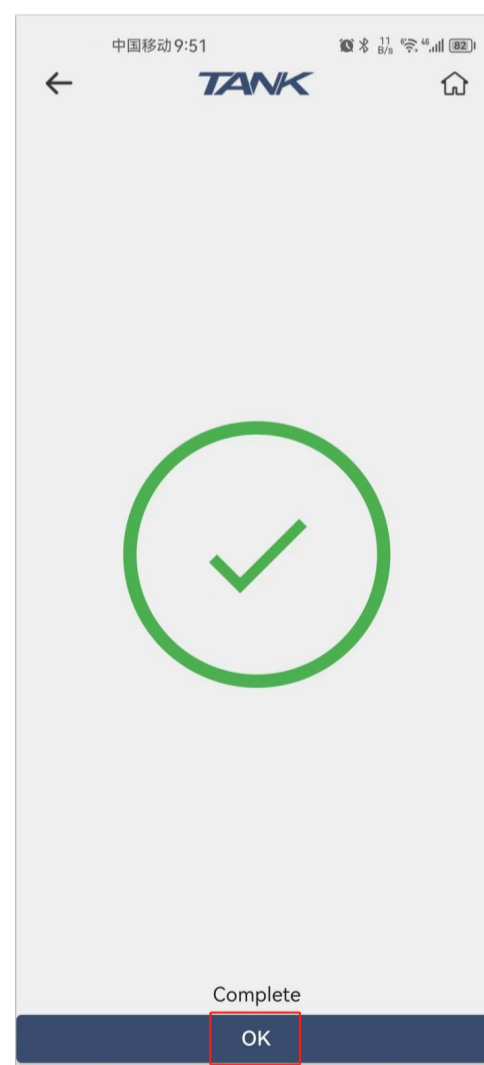

6-5、 Clamp calibration

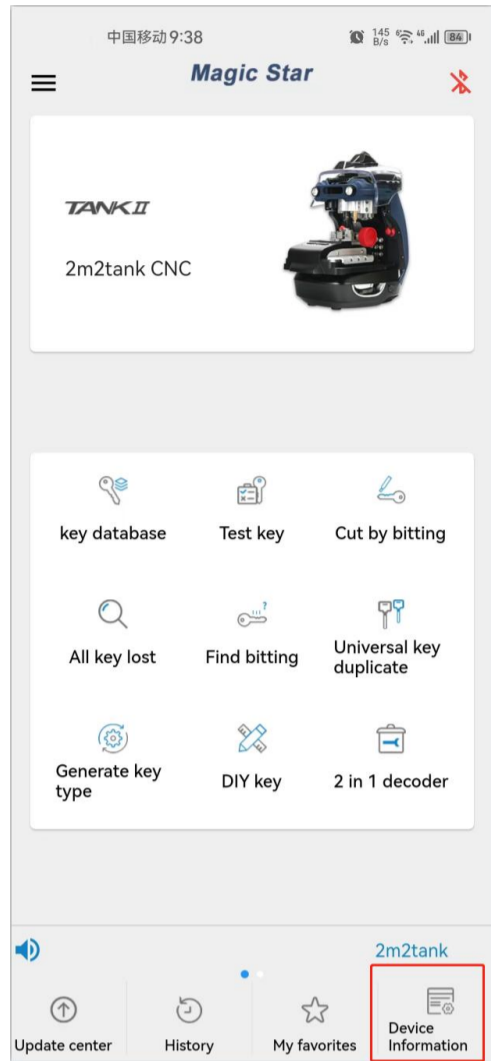

Enter 2M2 TANK interface,click “settings”

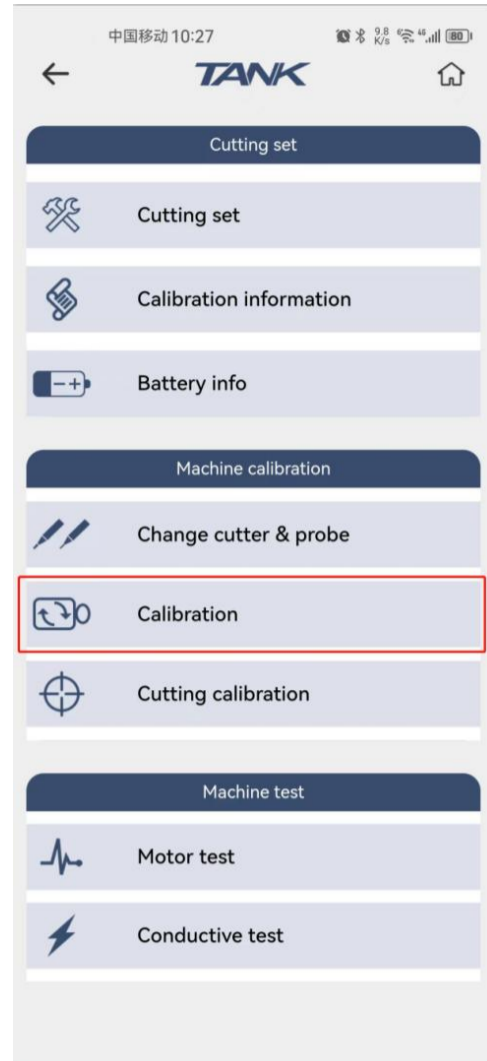

Click “clamp options”

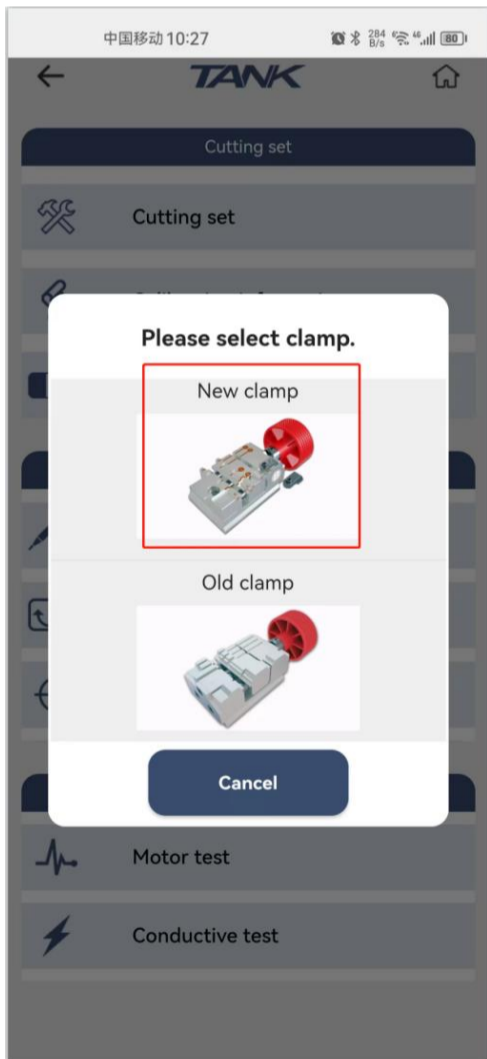

Select clamp depend on your current clamp”

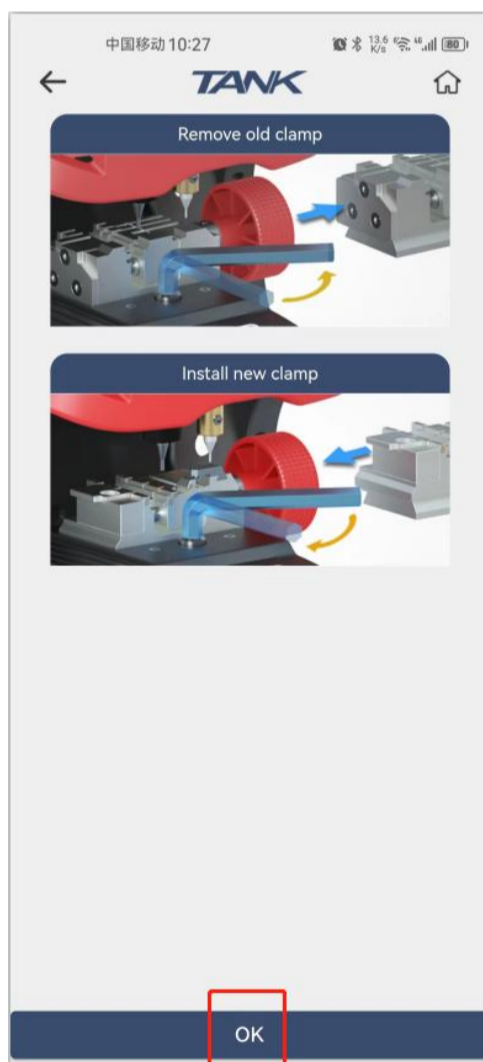

Remove the clamp from the picture instruction
(notes: If clamp B is ready, directly click “calibration”)

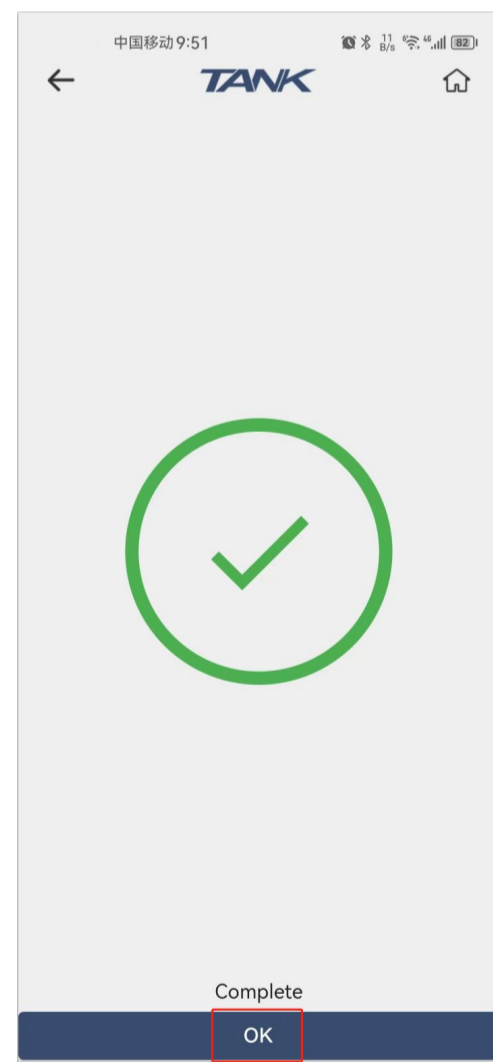

6-6、Cutting calibration

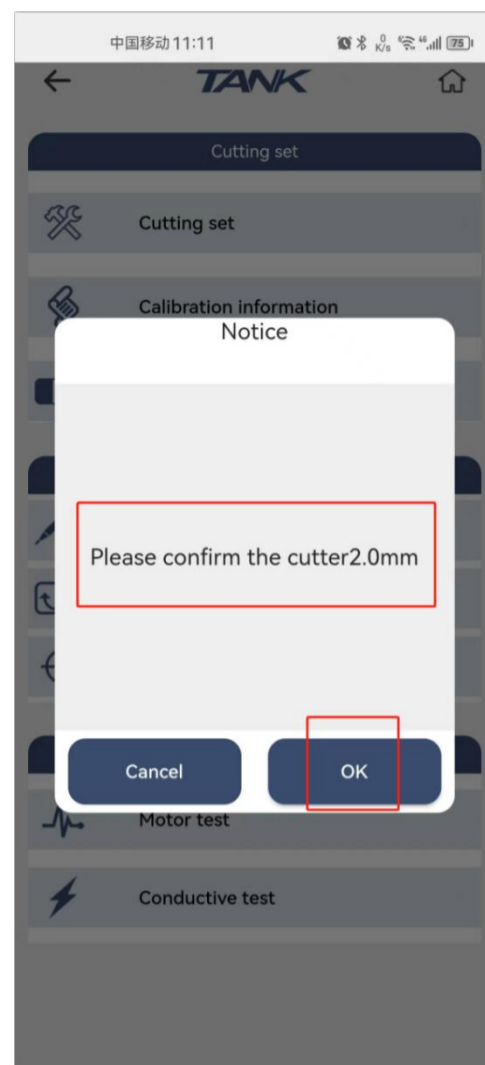
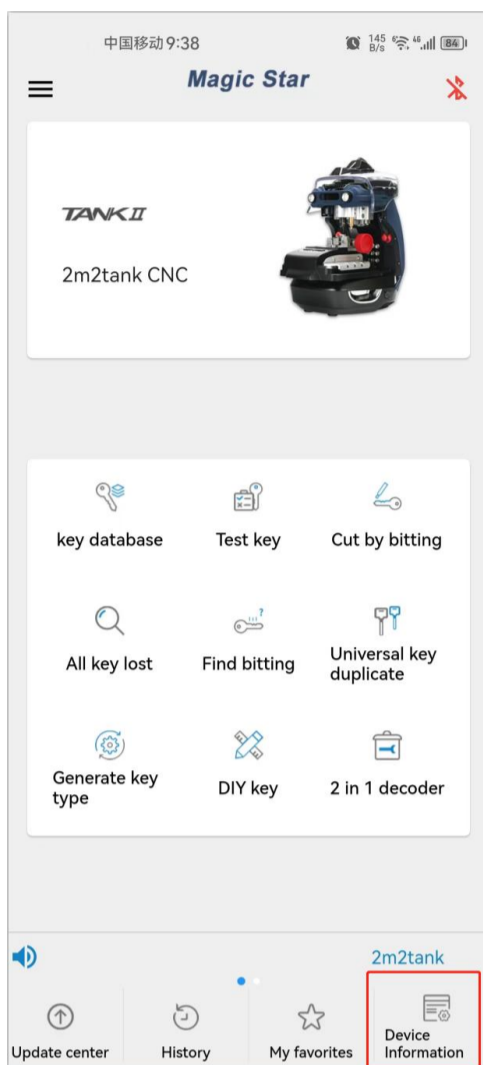

Enter 'Device information' --- 'Cutting calibration' ---- 'OK'

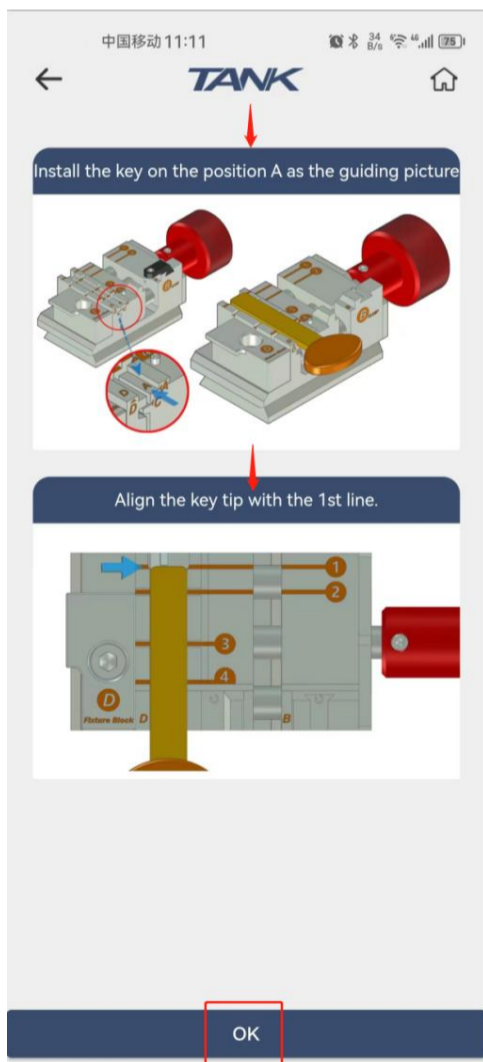

Install HON66 key blank,
Click "OK"

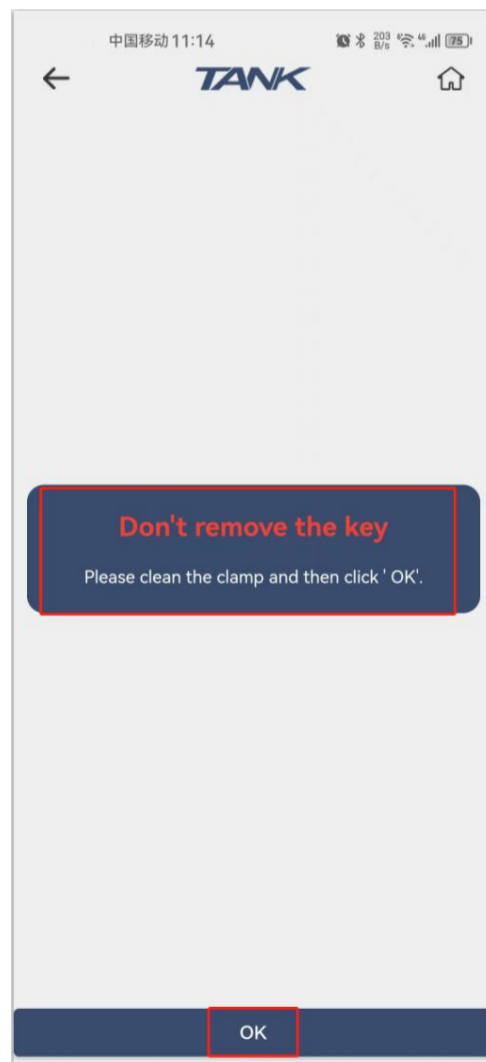

Clean the particles and click "OK"

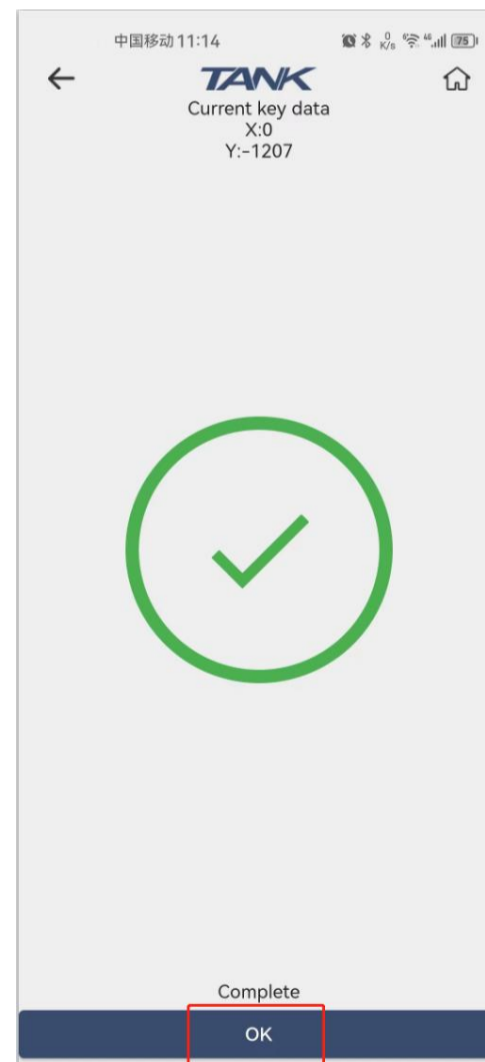

If it's ready, click "OK"

7、 How to use 'Key database' ? (Buick as sample)

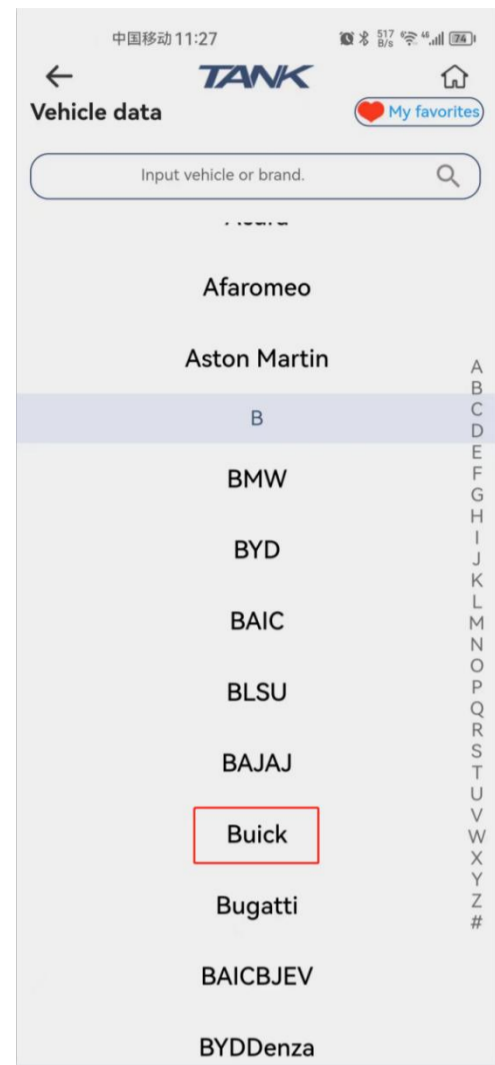
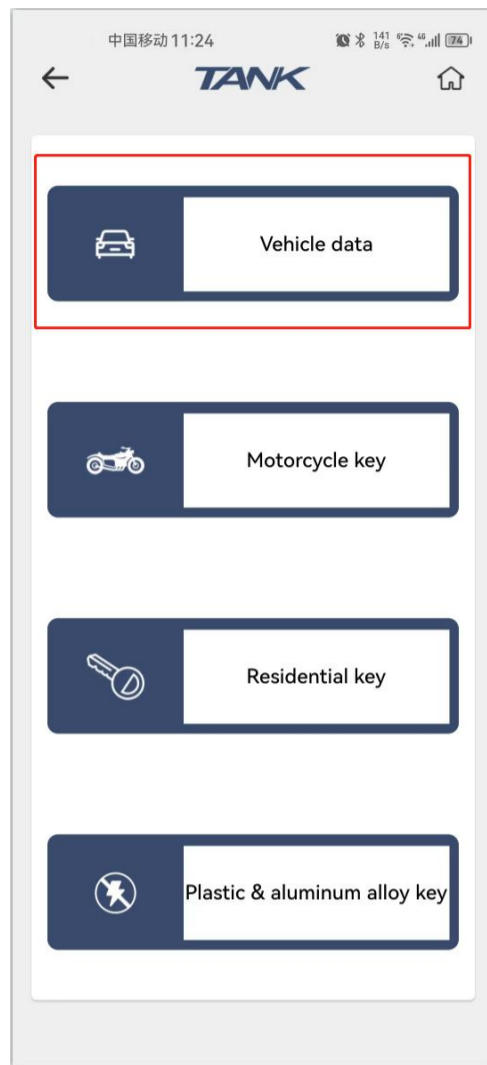
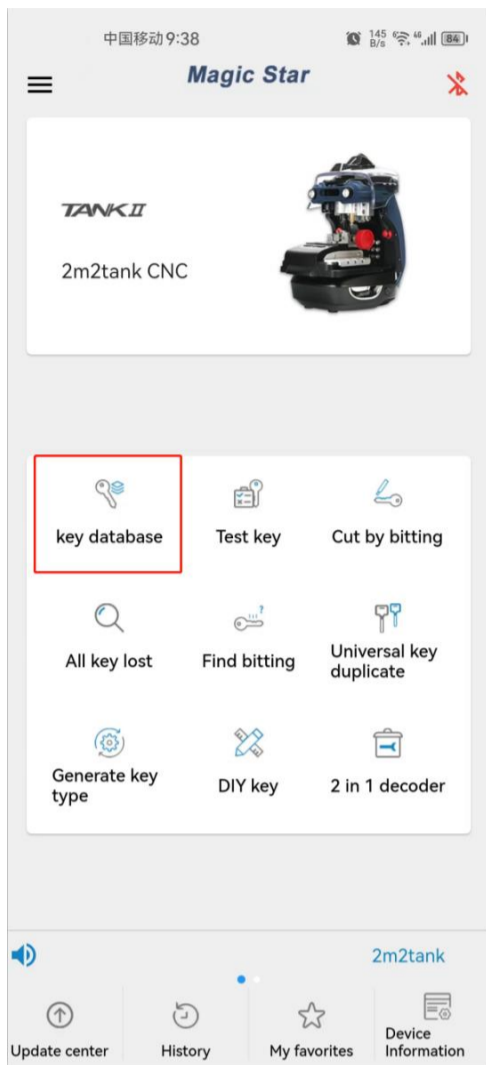

Click 'key database' --- 'vehicle key' --- 'Buick'

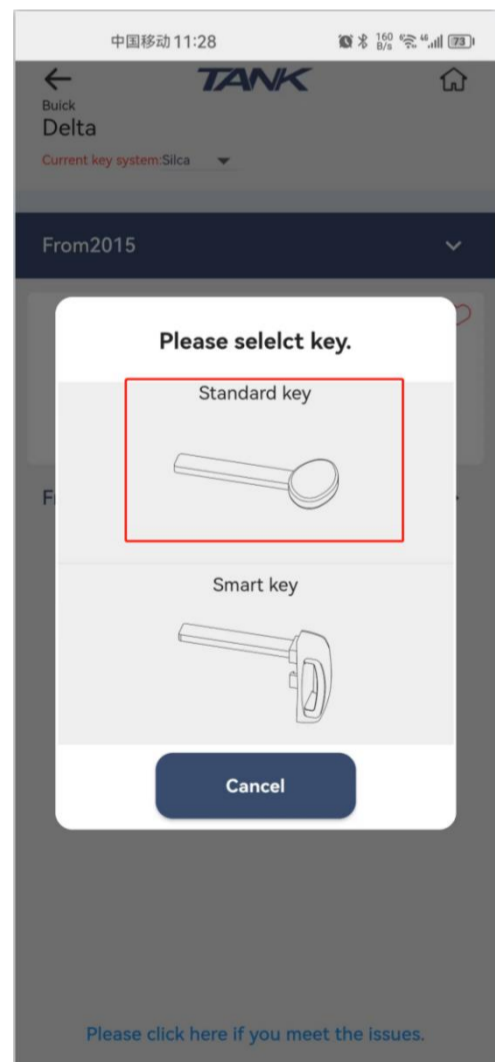
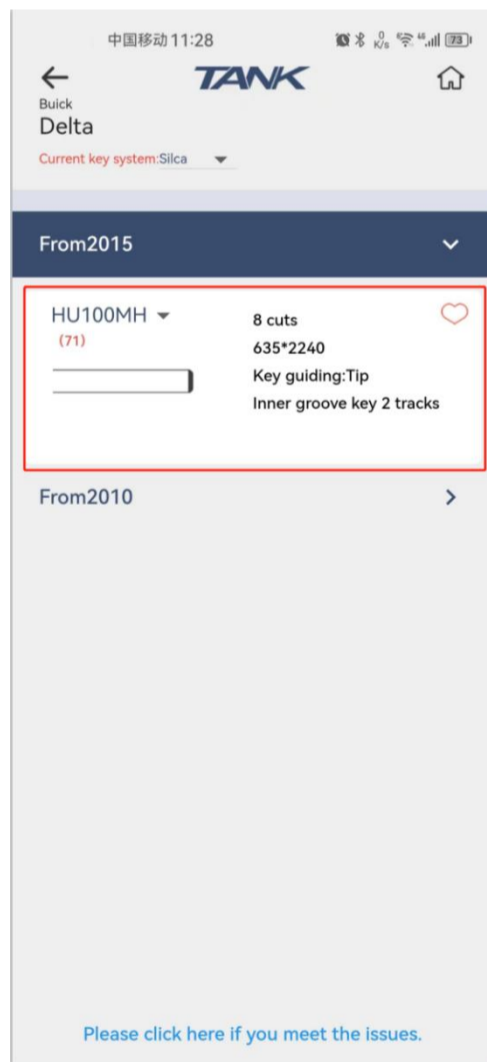

Click 'Delta' --- 'HU100' --- 'Standard key'

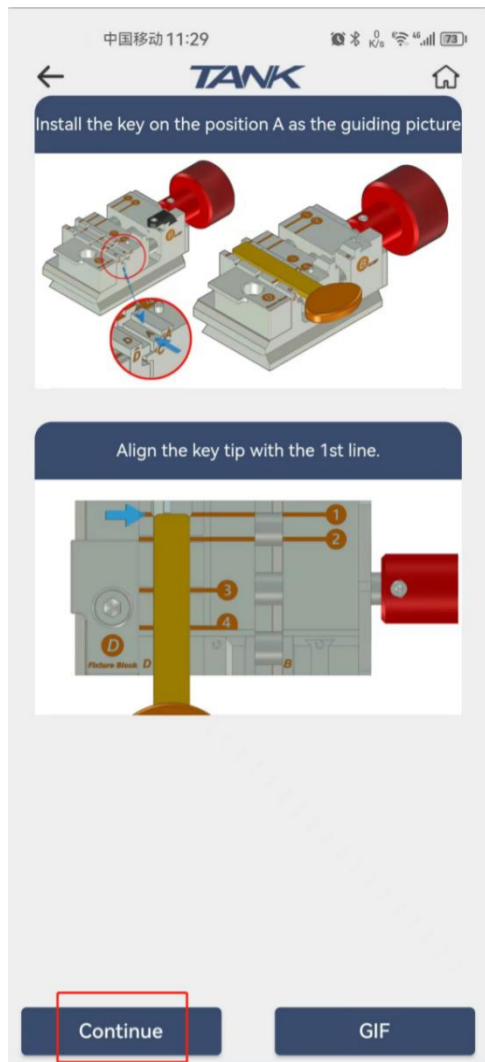

Click 'Continue' --- 'Continue'

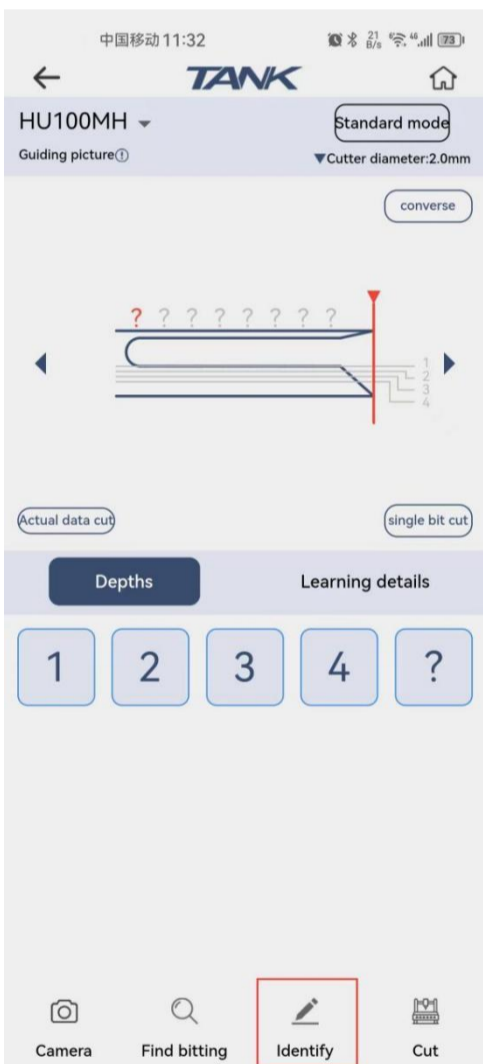
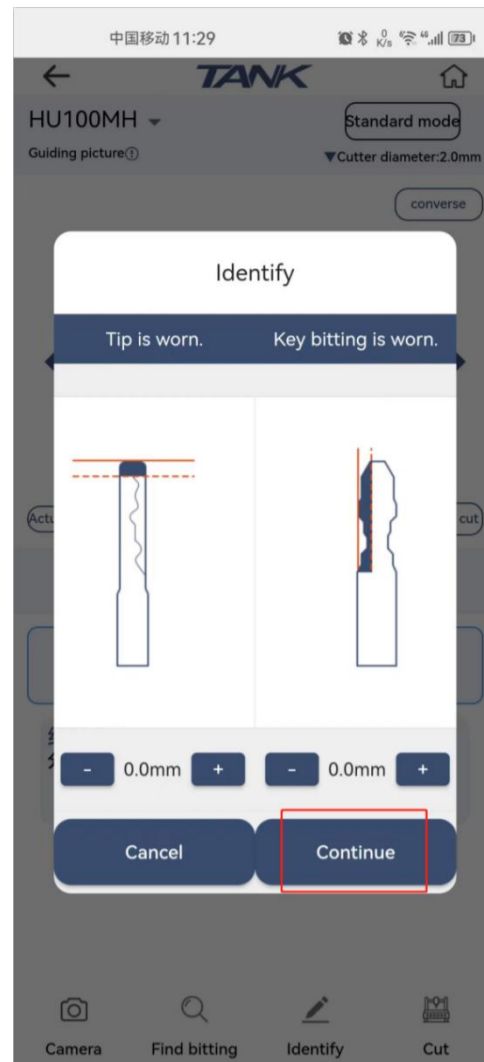

Click "Identify"

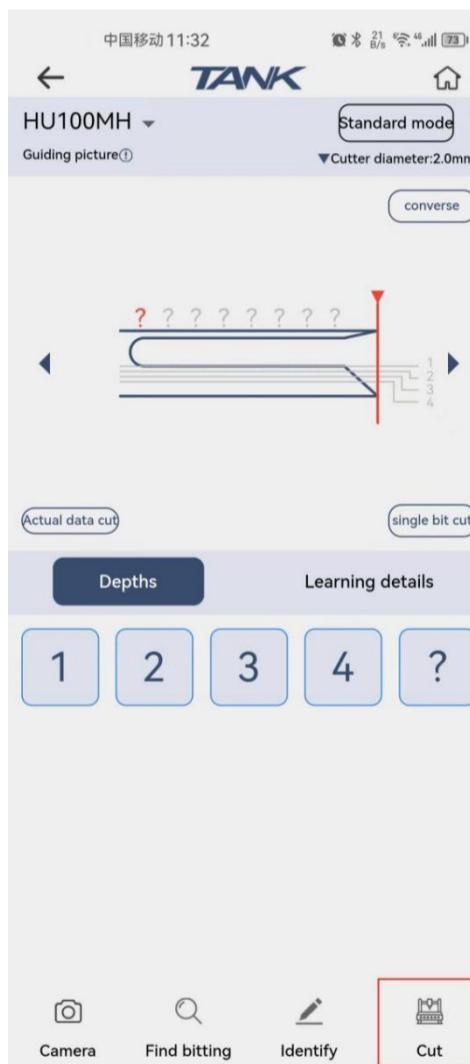

Click "cut"

*Operation depend on App guide

8、 How to use all key lost

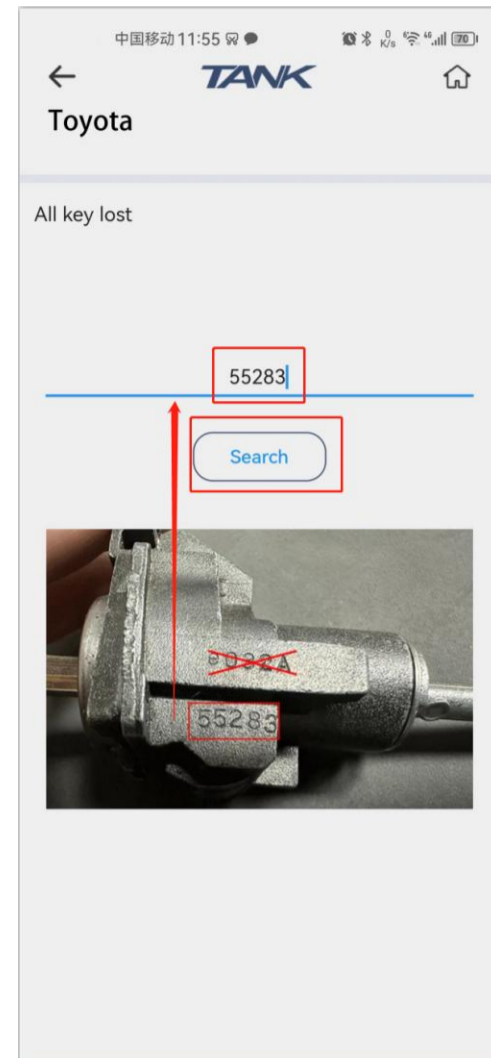
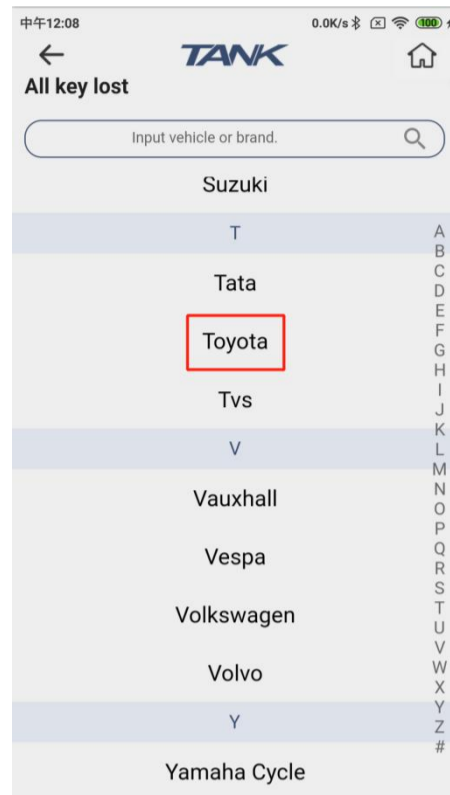
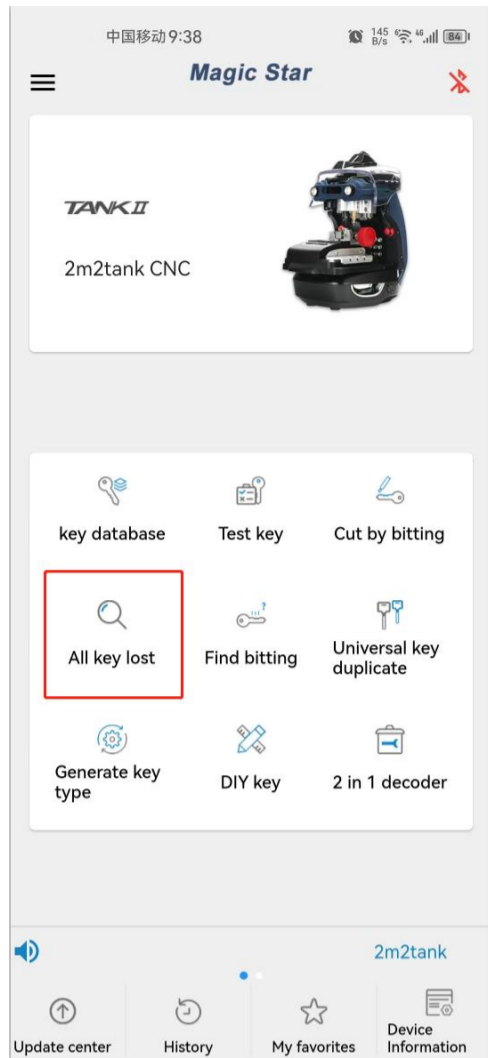

Click 'all key lost' --- 'Toyota' --- Input 'lock number' --- 'search'

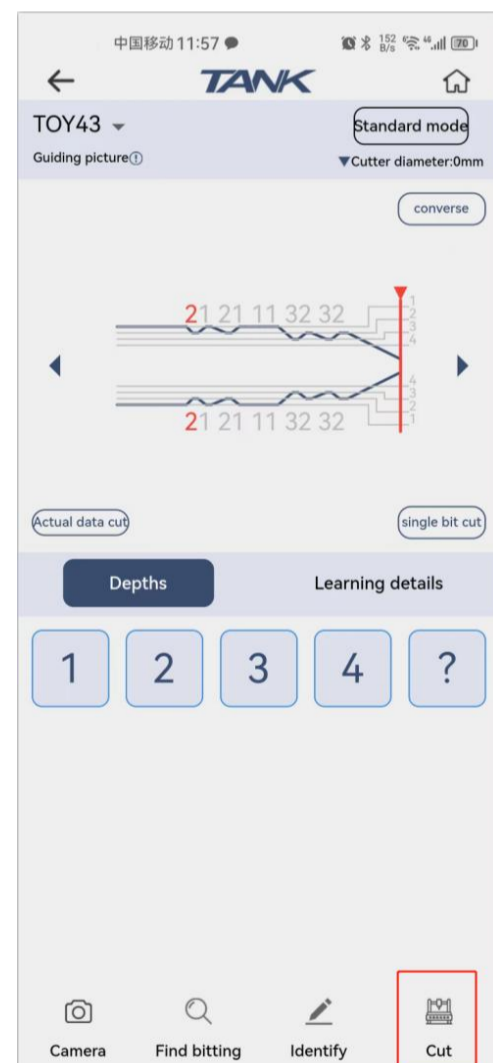
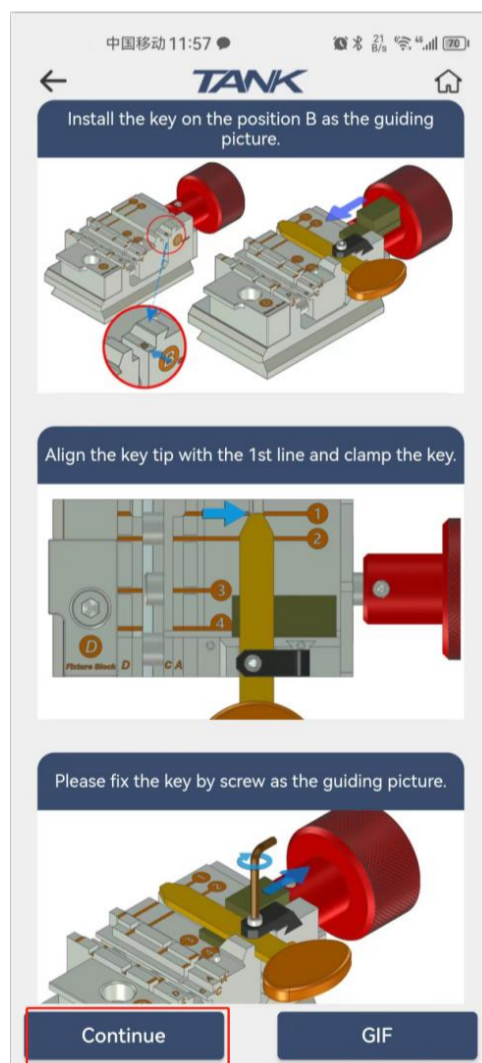
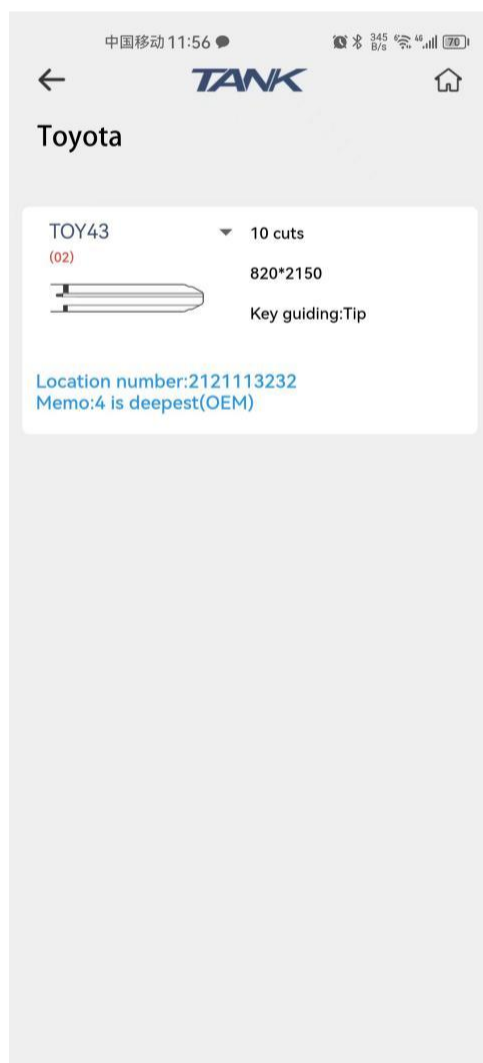

Click 'TOY43' --- 'Continue' --- 'Cut'

*Operation depend on App guide

9、 How to use 'Find biting' ? (Toyota as sample)

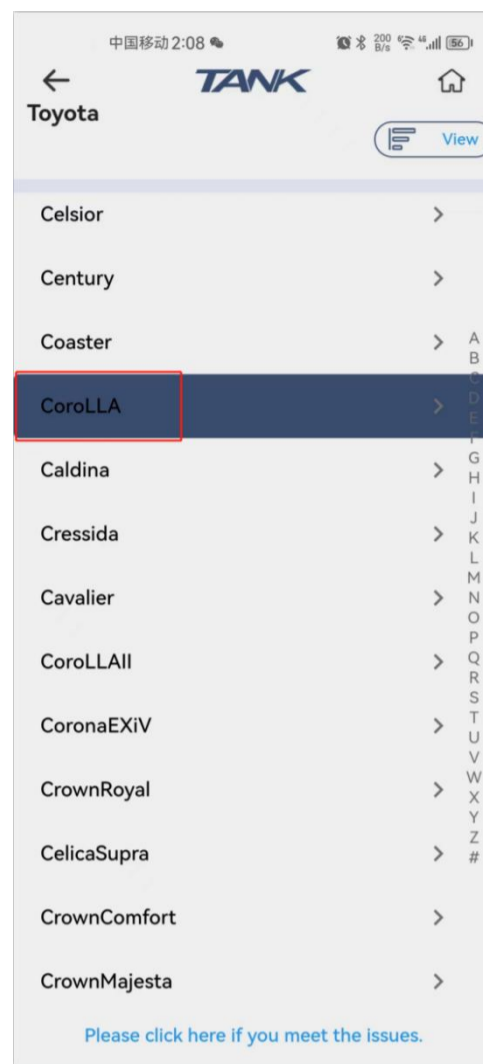
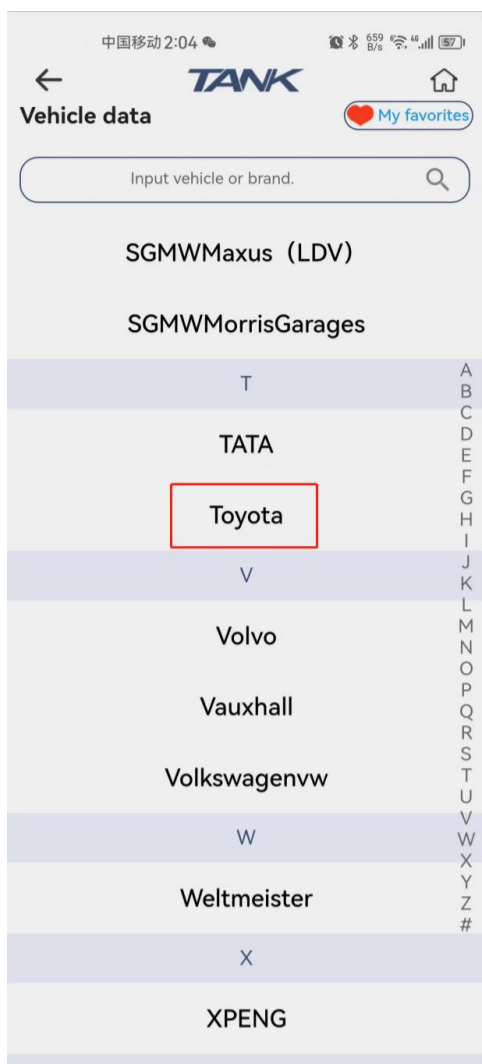
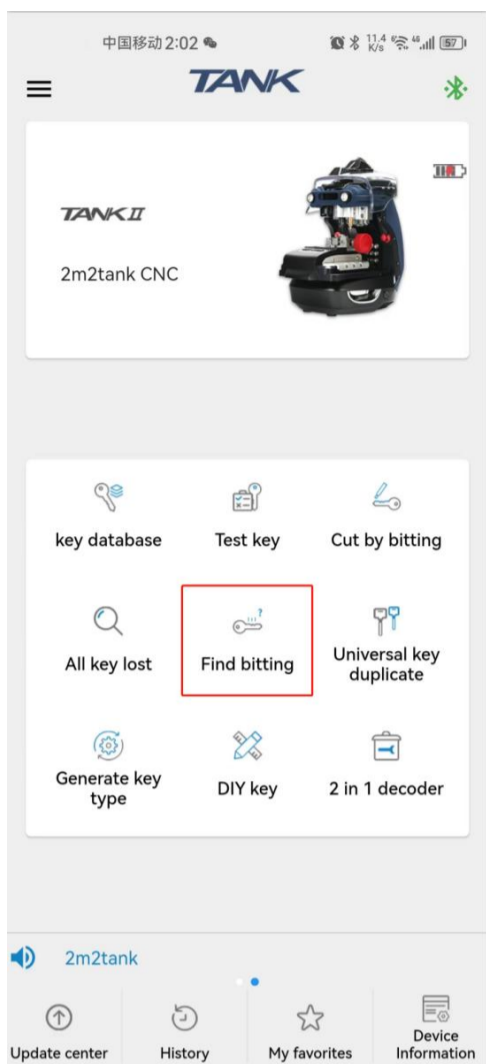

Click 'find biting' --- 'Toyota' --- 'Corolla'

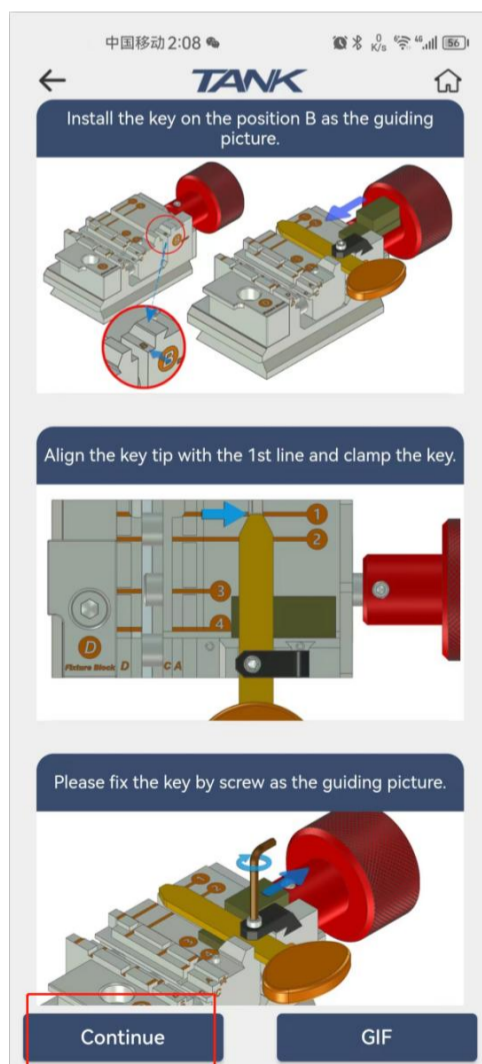
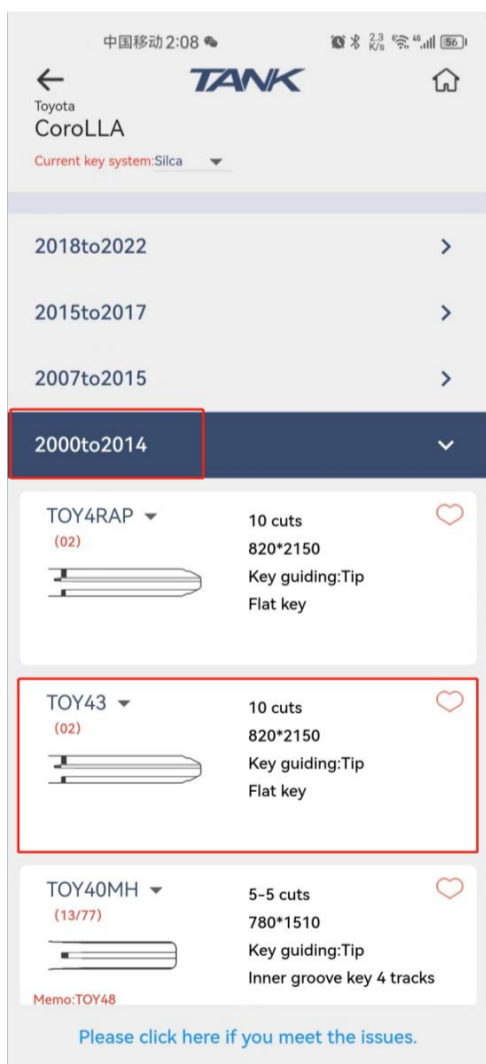

Click 'TOY43' --- 'Continue' ---

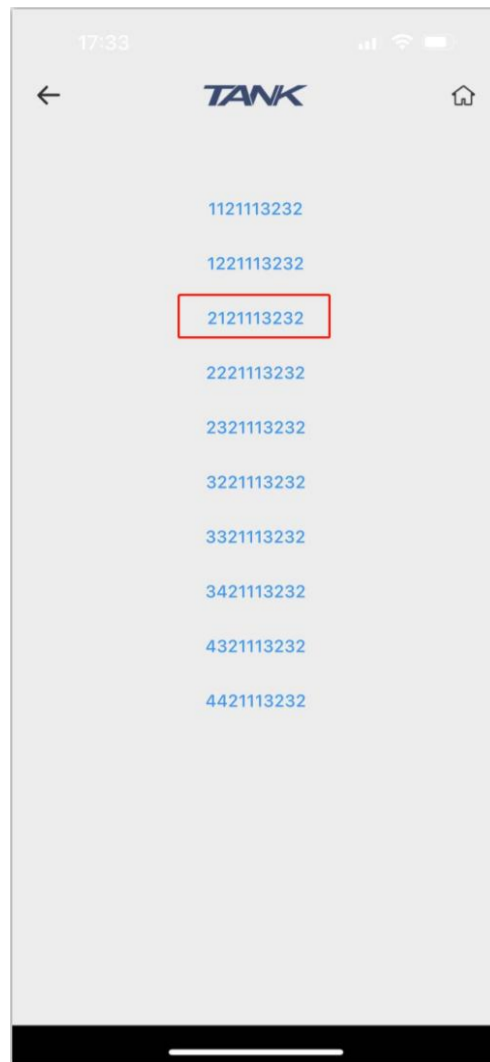
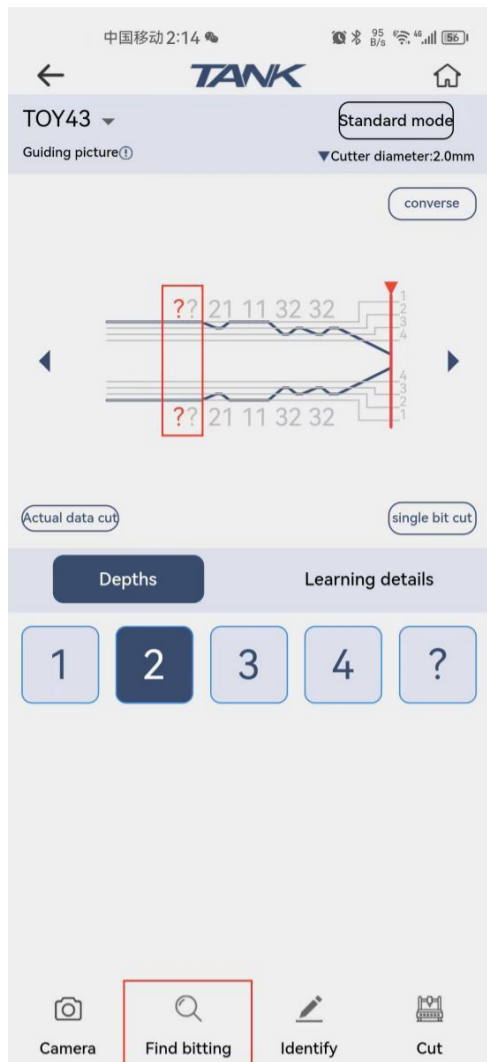

Input door bitting and then click 'Find bitting'

If key bitting appear, and then cut it one by one.

*Operation depend on App guide

10、How to use 'universal key duplicate' ? (Inner groove key 2 tracks as sample)

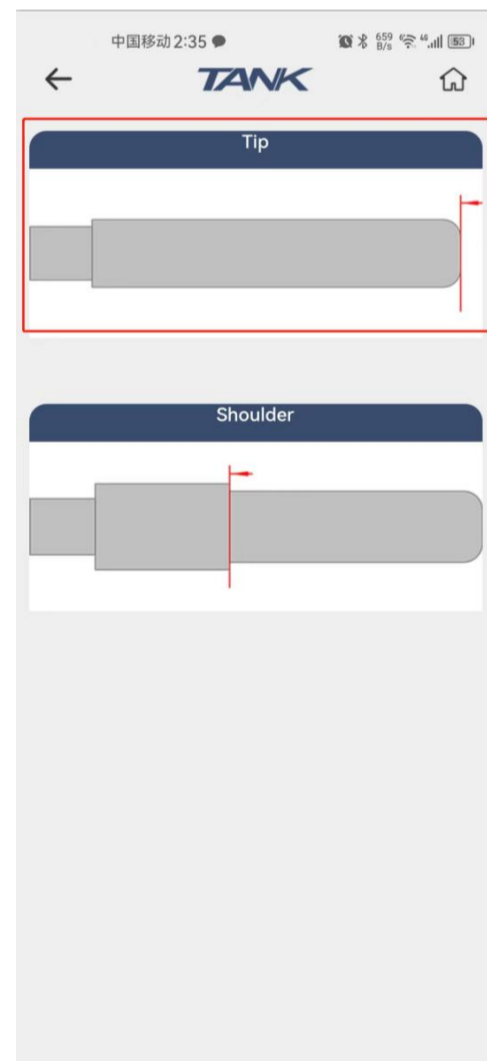
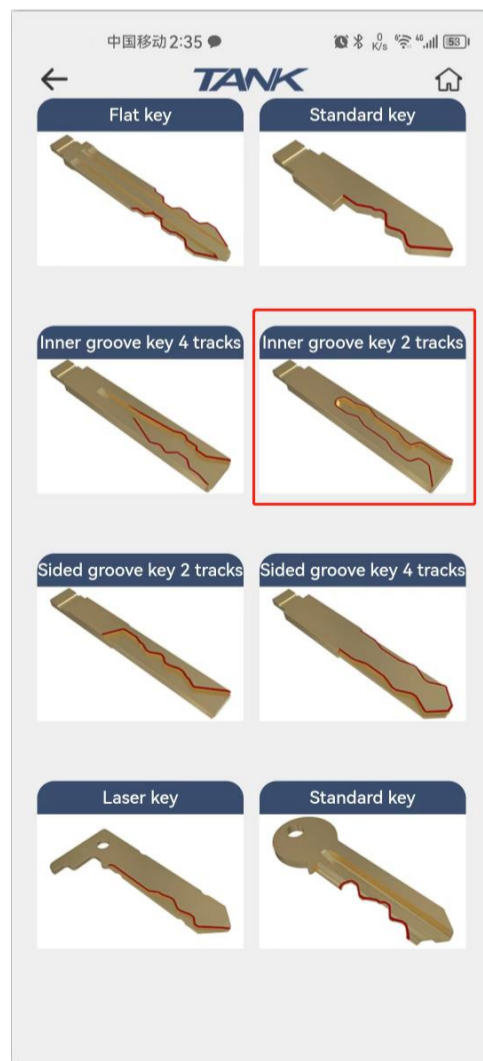
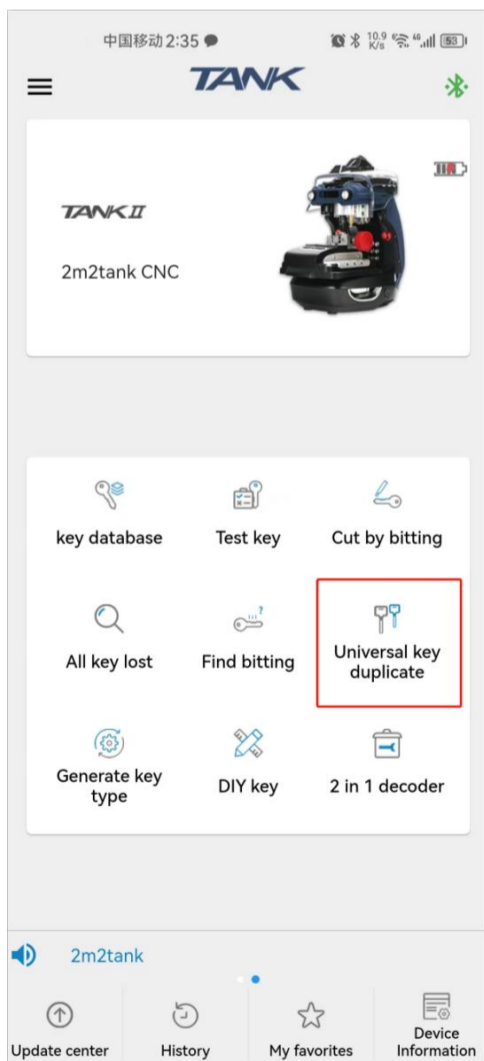

Click 'universal key duplicate' --- 'Inner groove key 2 tracks' --- 'Tip'

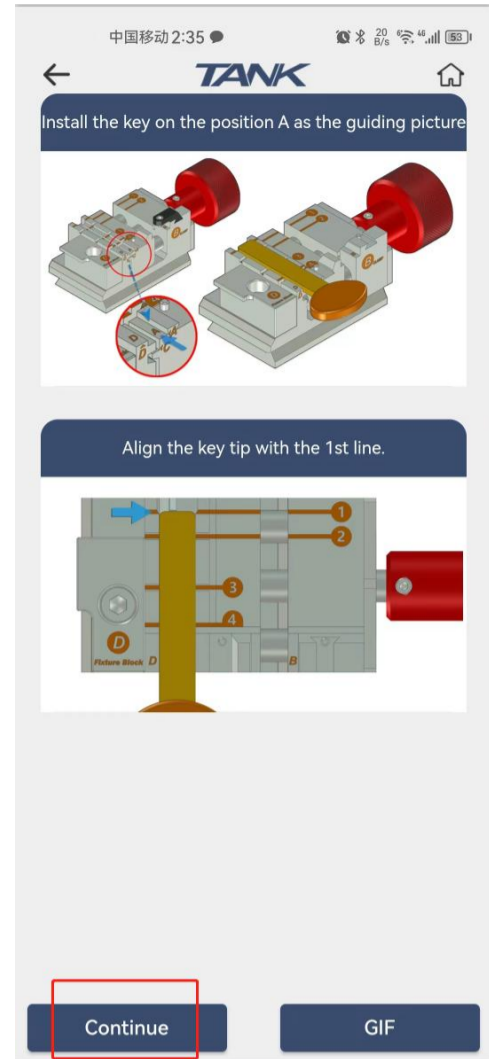
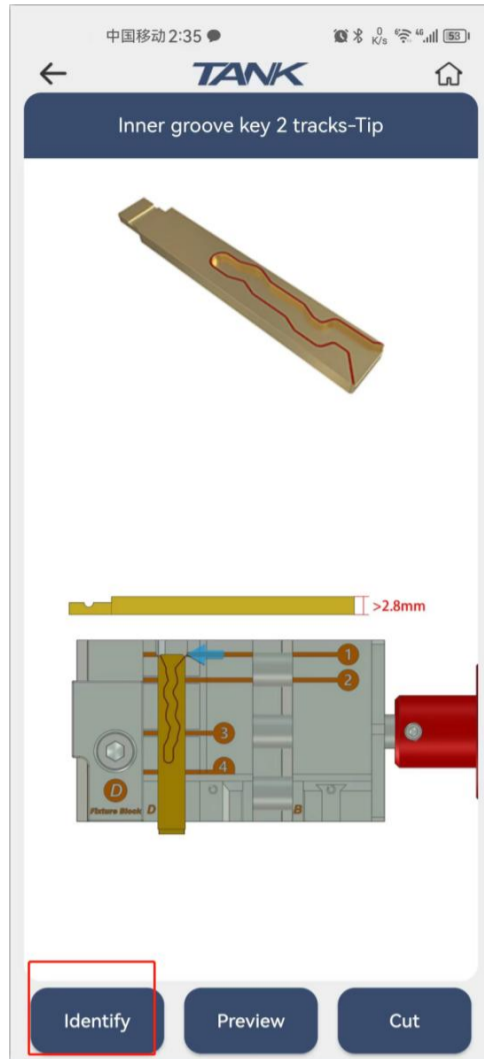
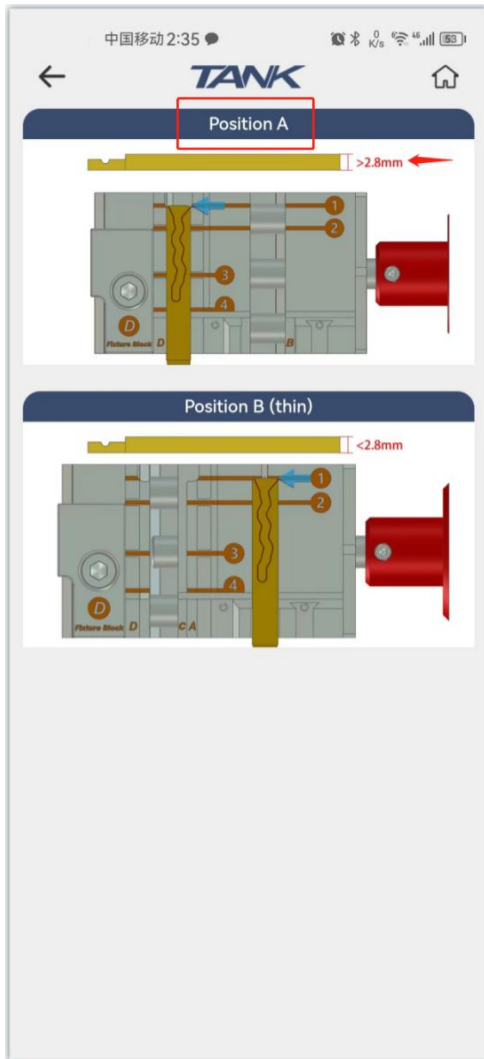

Select ' $>2.8\text{mm}$ ' --- ' Identify' --- 'Continue'

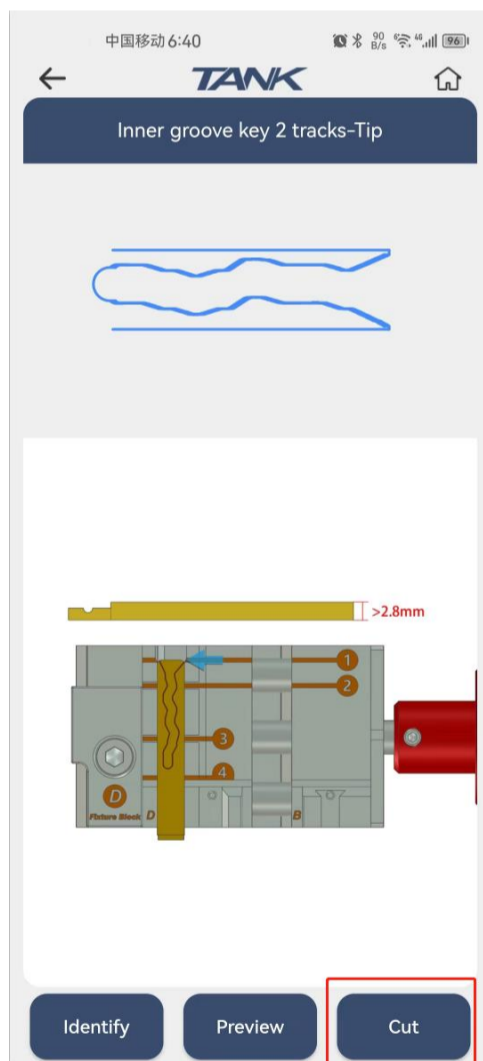
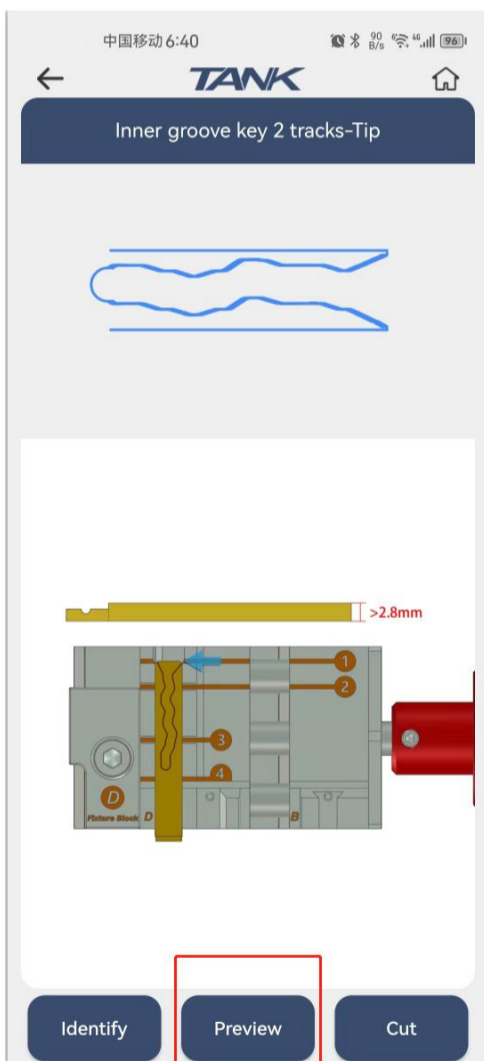

Click 'View' --- 'Cut'

11、How to use generate key type?

11-1、Generate key type (HU100 as sample)

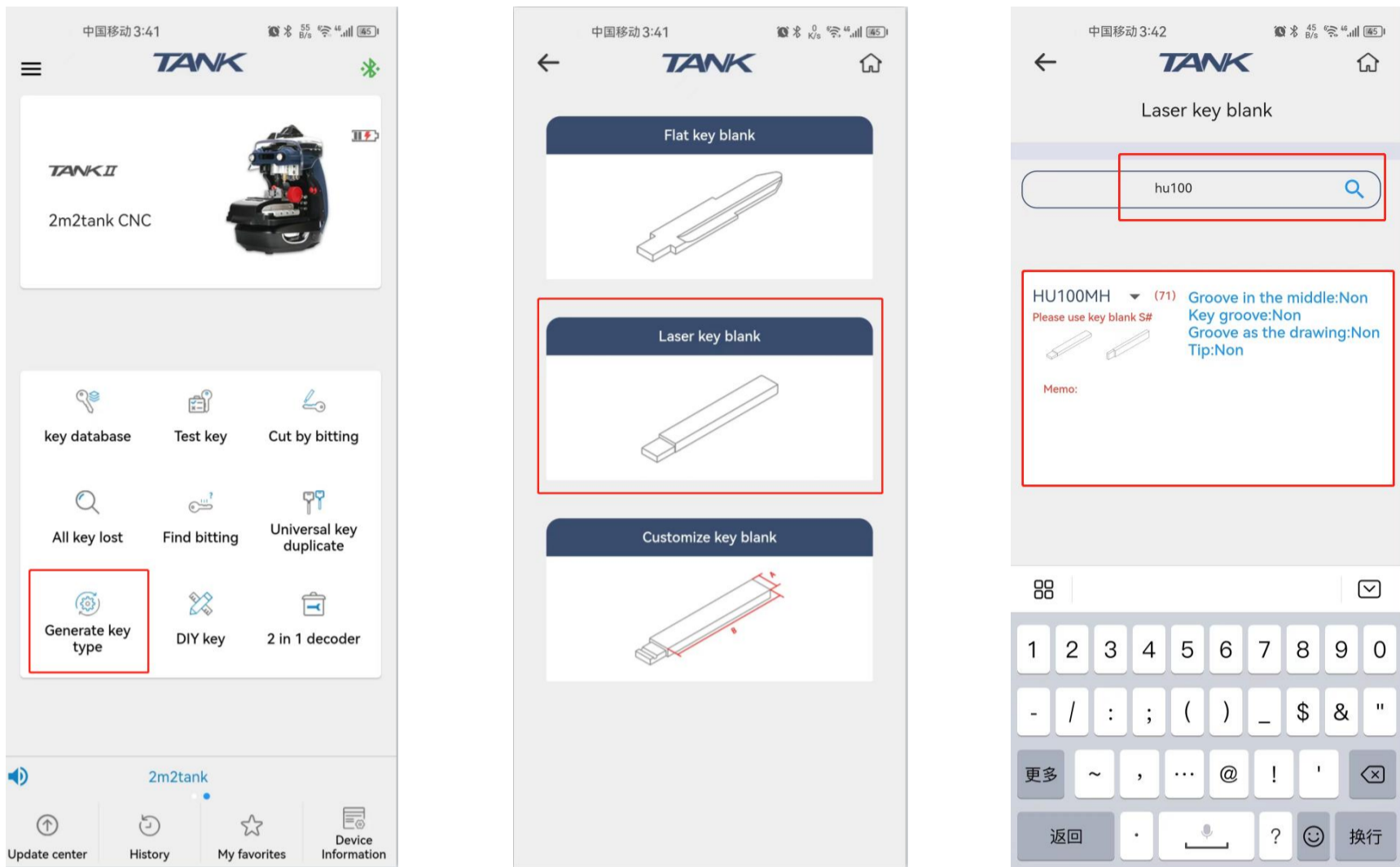

Click 'generate key type' --- 'Laser key blank' --- 'HU100'



Select 'key blank S#' --- 'Continue'

(*notes: This function just generate key blank, Operation depend on App guide)

11-2、How to DIY key blank? (HU66 as sample)

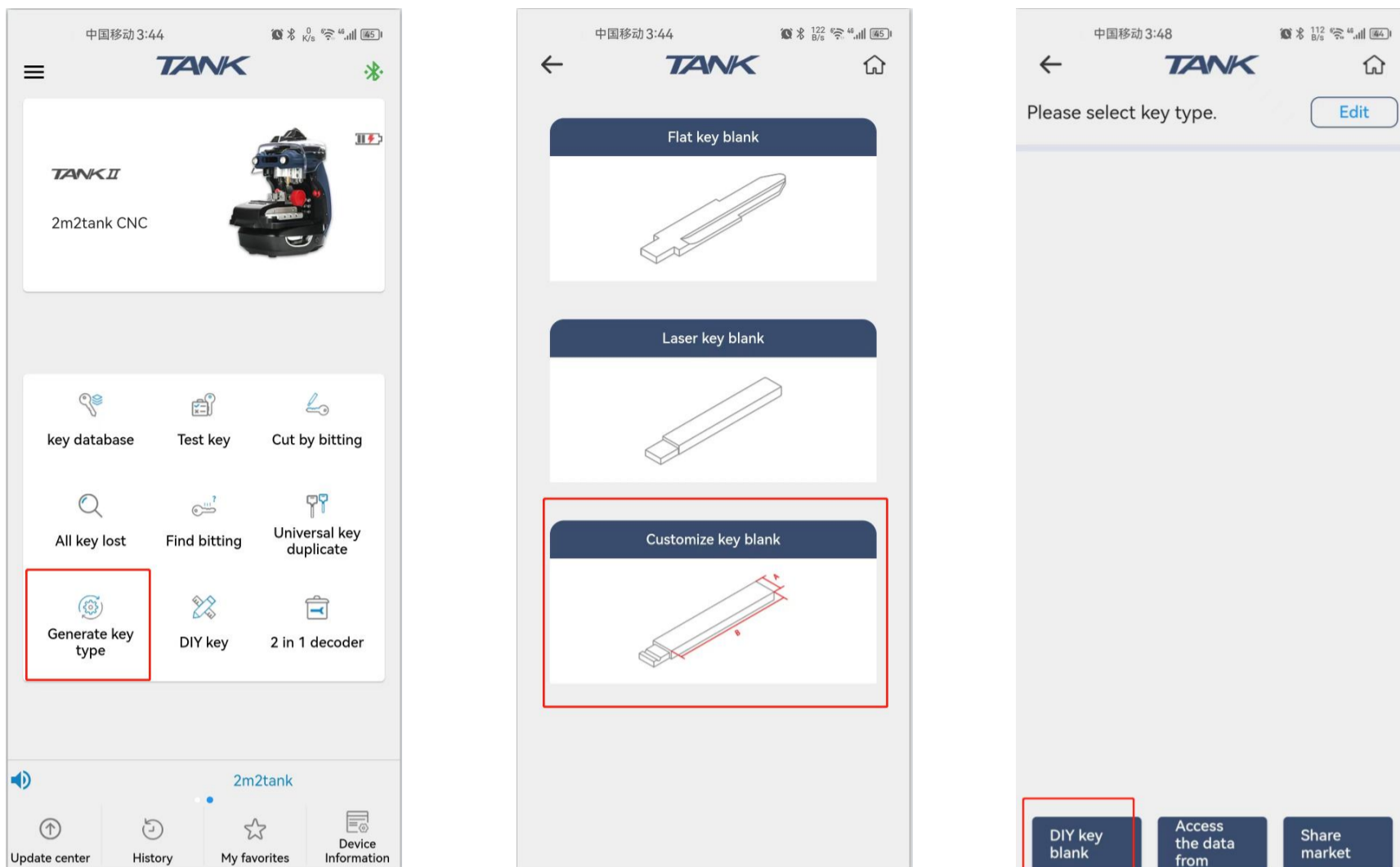

Click 'Generate key type' --- 'Customize key blank' --- 'DIY key blank'

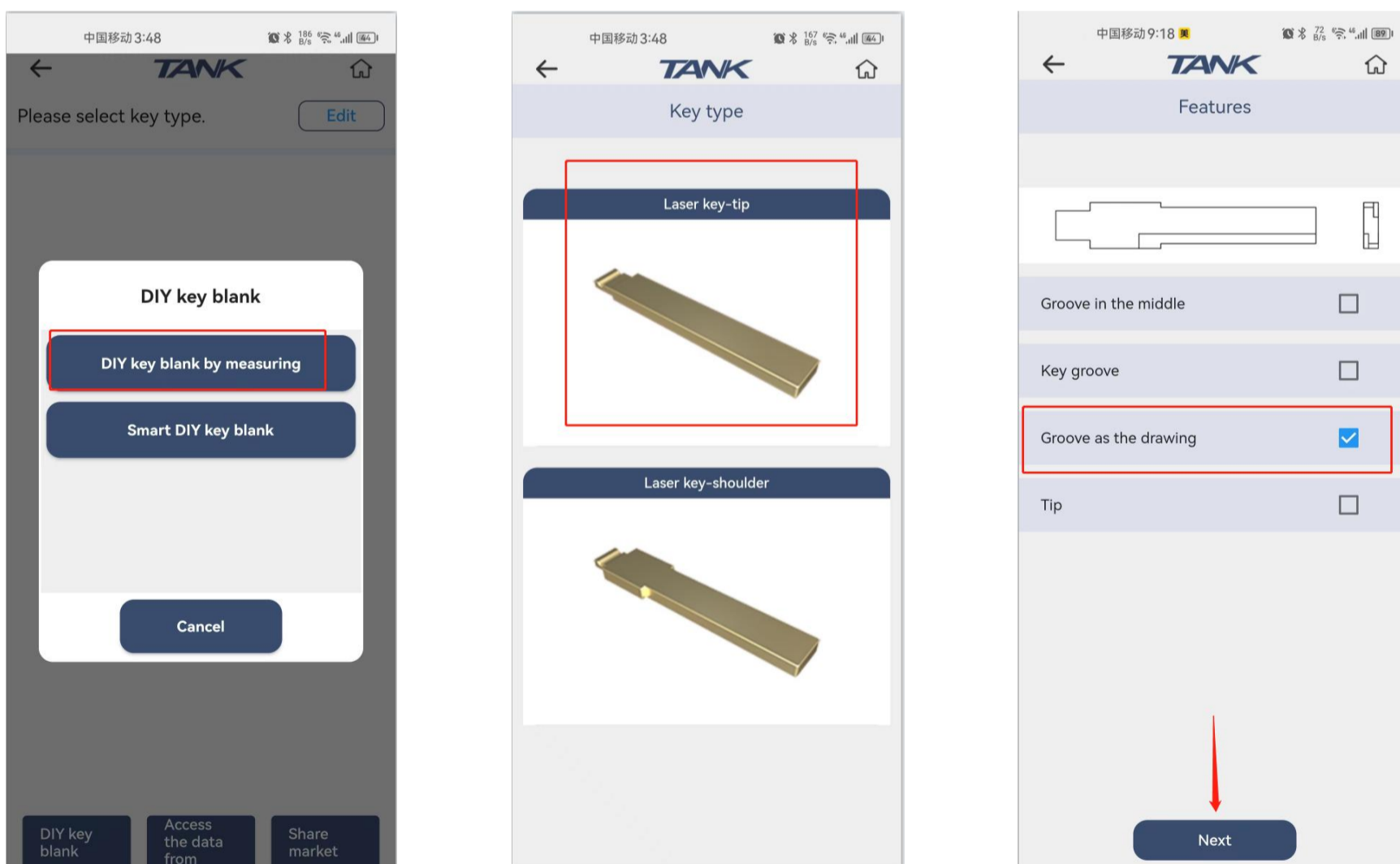

Click 'DIY key blank by measuring' --- 'Laser key-tip' --- 'Groove as drawing' --- 'next'

(Unit is 0.01mm)

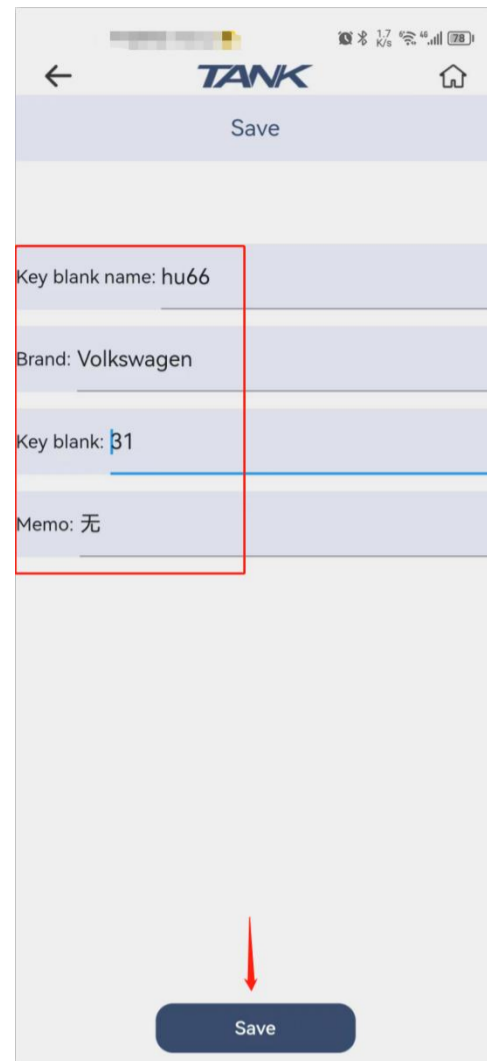
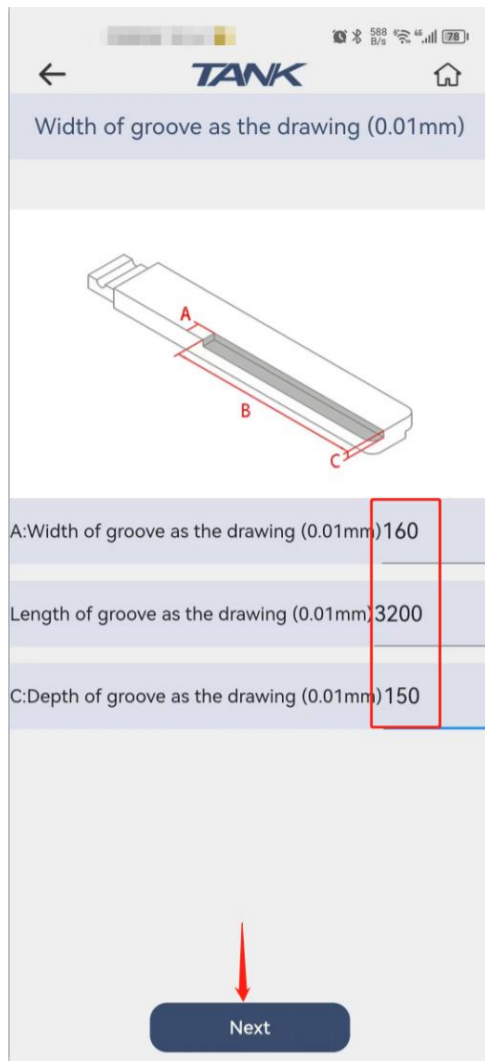
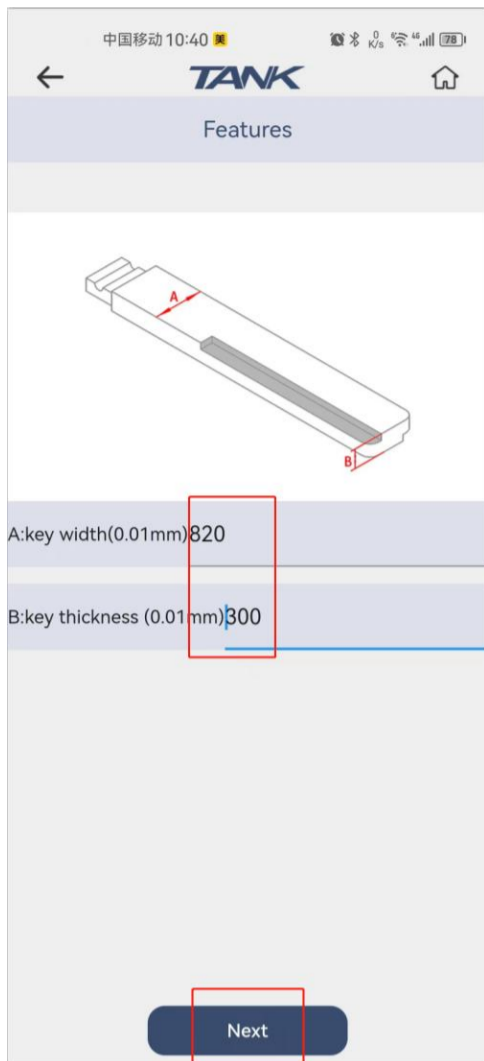

Please input key width, thickness and others depend on measuring.

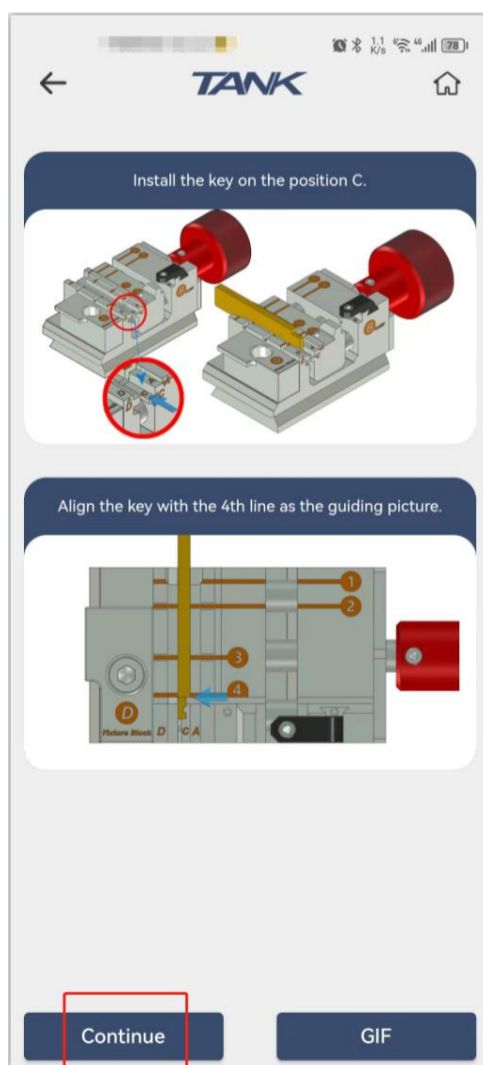
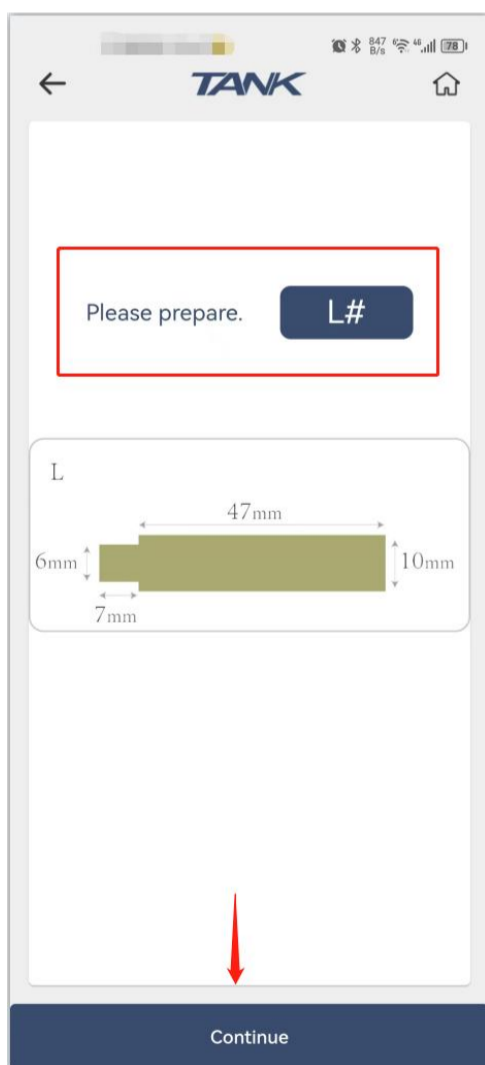

Input key blank name and vehicle information and then click 'save', operation depend on the APP guide

12、How to use 'DIY key' ? (Hu66 as sample)

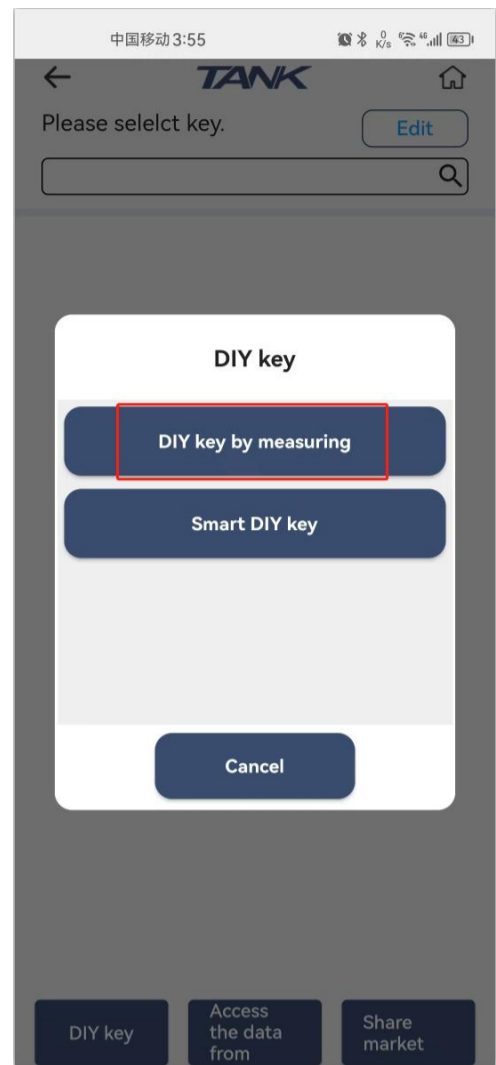
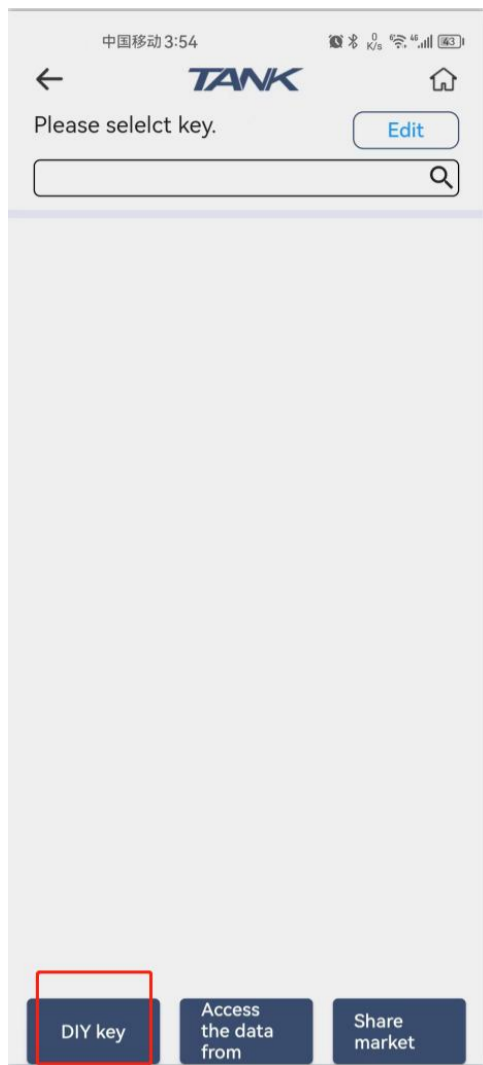
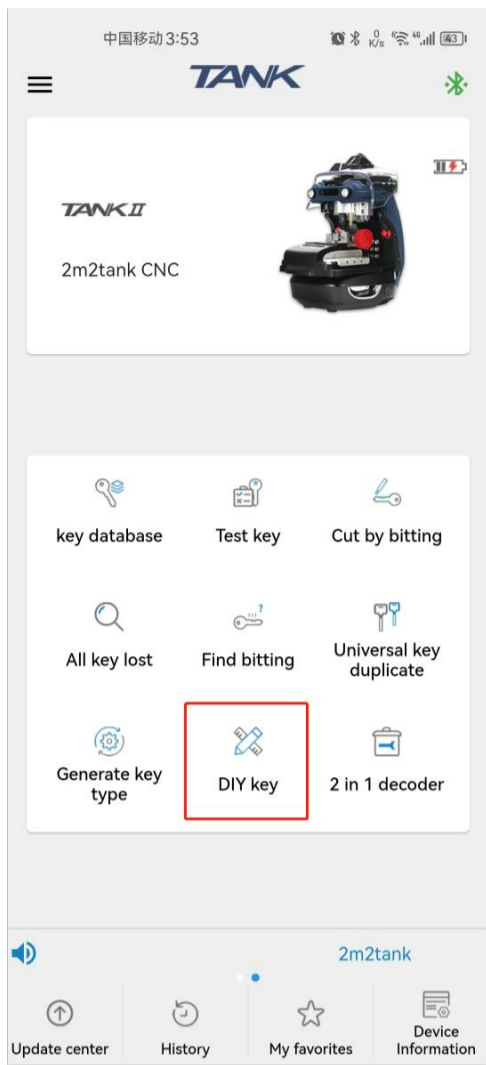

Click 'DIY key' --- 'DIY key' --- 'DIY key by measuring'

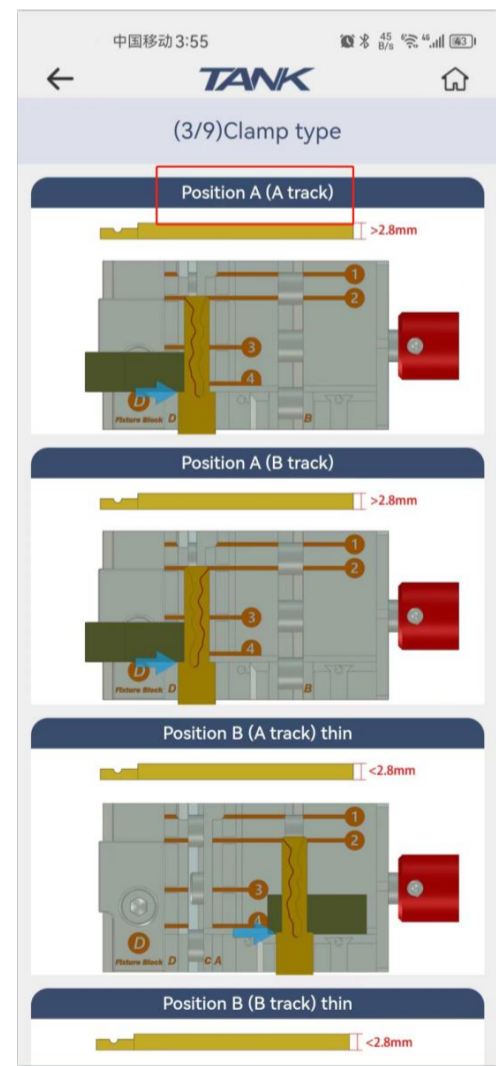
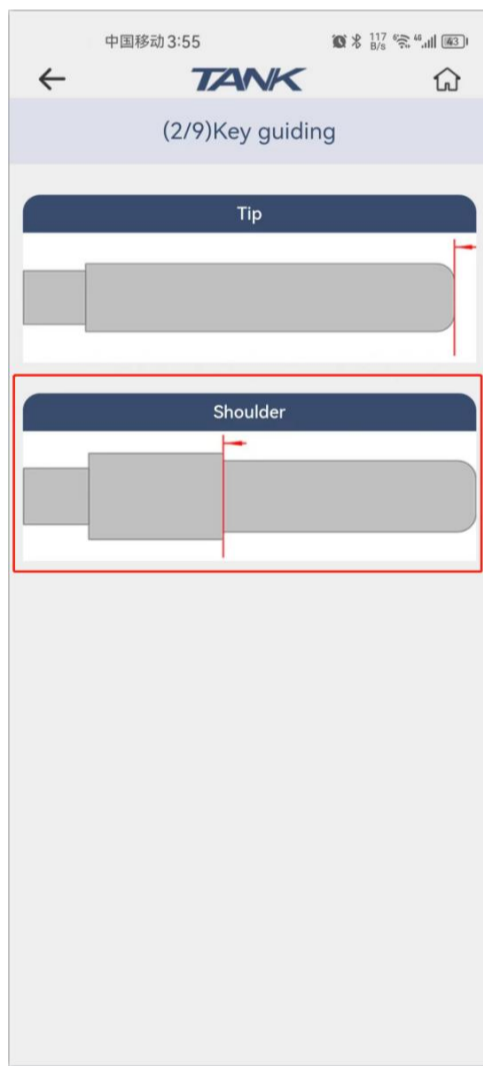
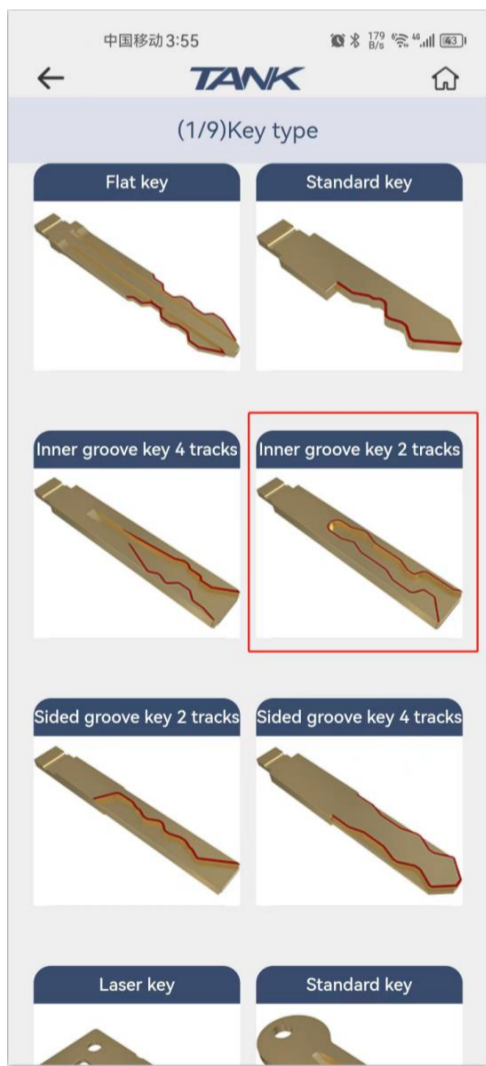

Click 'Inner groove key 2 tracks' --- 'Shoulder' --- 'Position A (>2.8mm)'

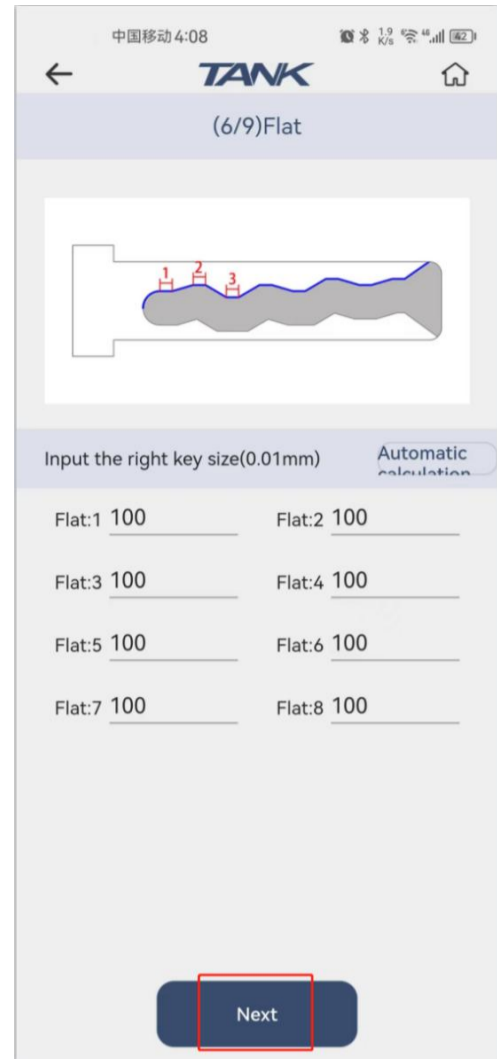
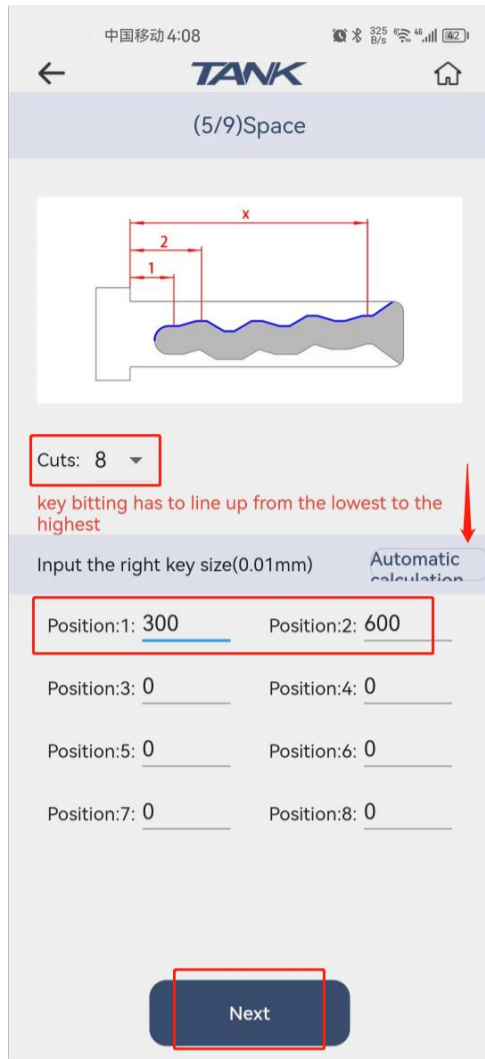
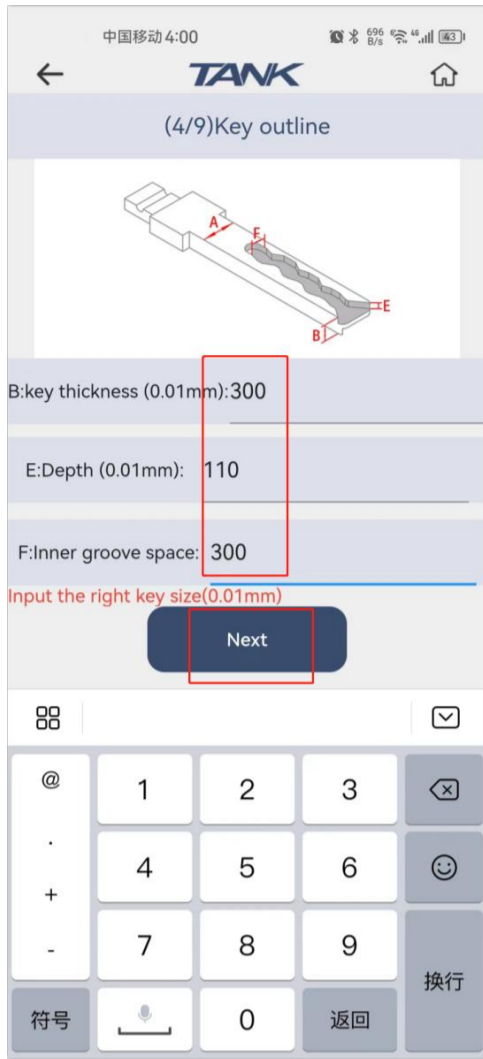

Input key thickness, Depth and other information after measuring (as guide above), and then click 'next' .

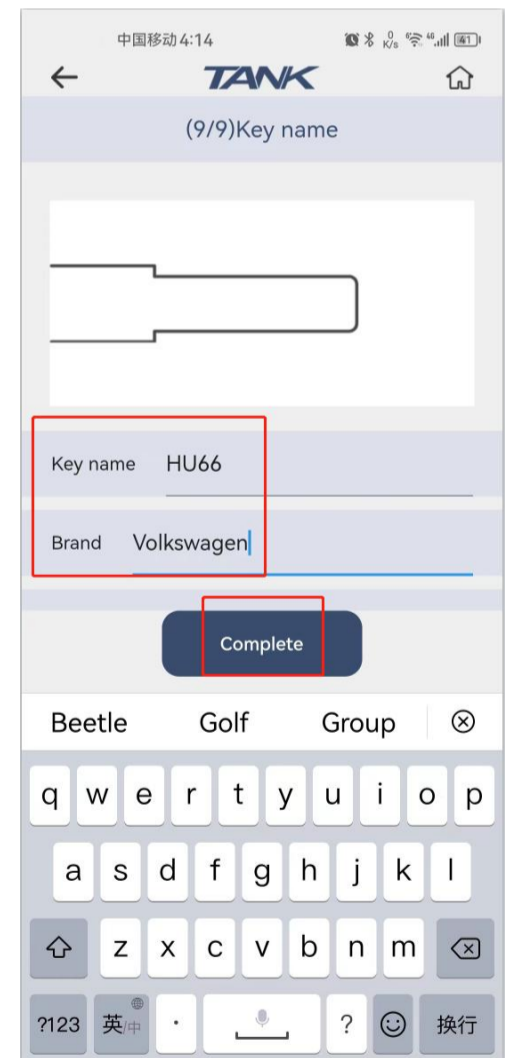
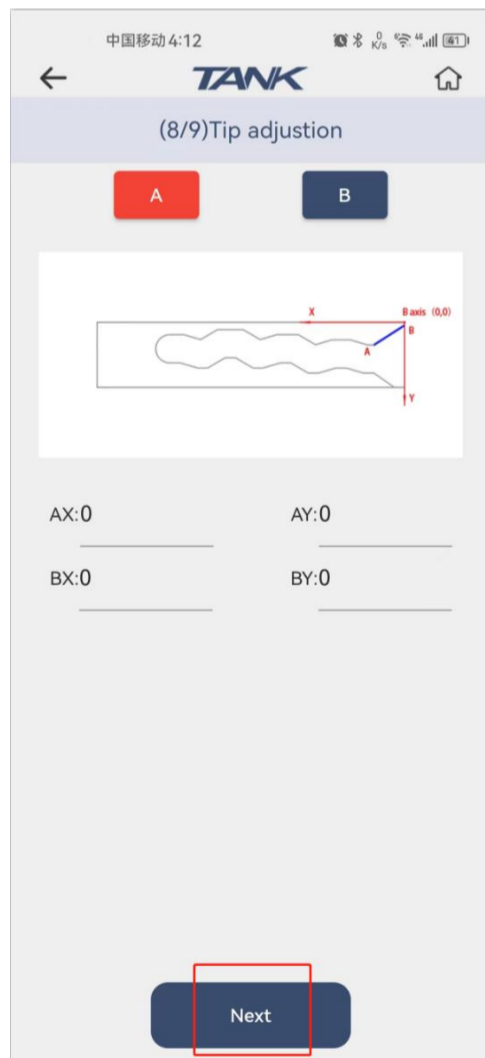
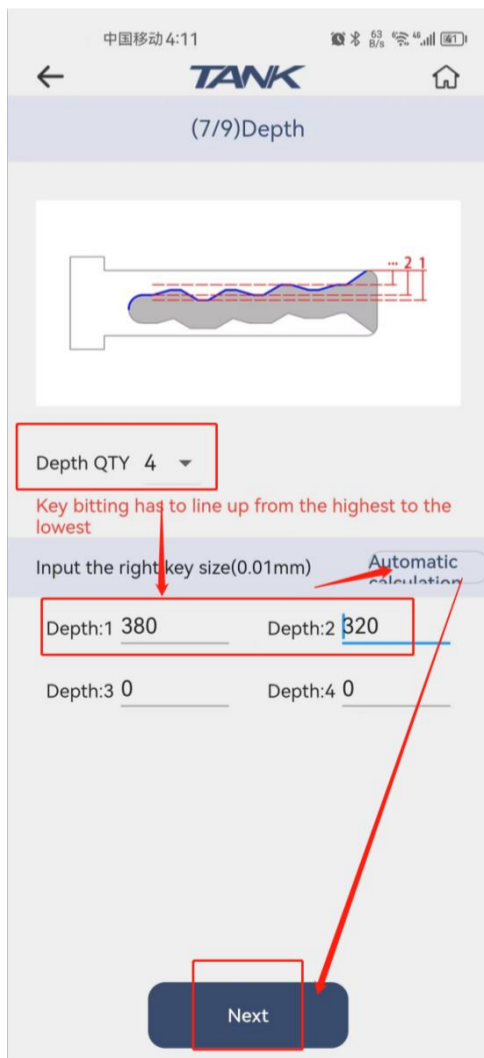

Select Depth QTY and then input volume after measuring. Input name and click ' complete' .

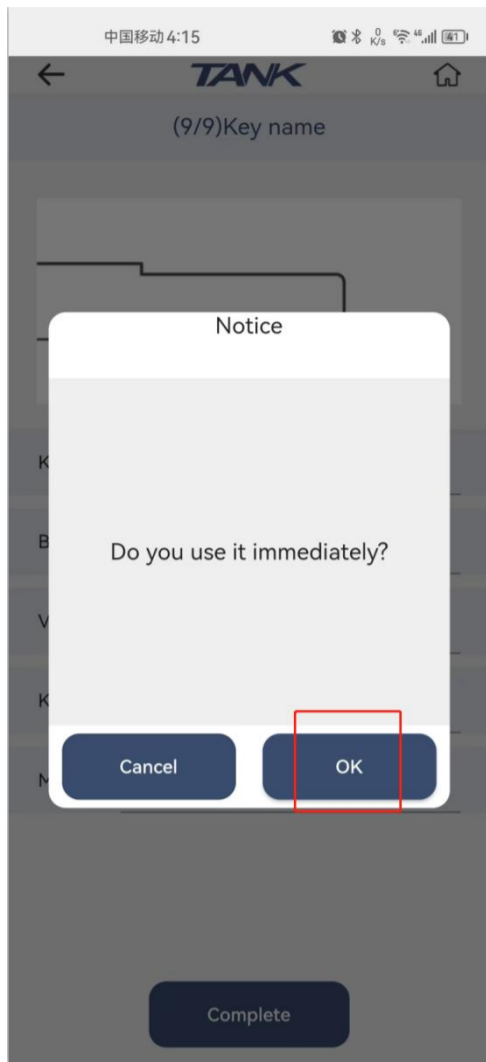

Click : 'OK'

***Operation depend on App guide**

13、 2 in 1 decoder

13-1、 How to use '2 in 1 decoder' ? (HU162T-9 cuts as sample)

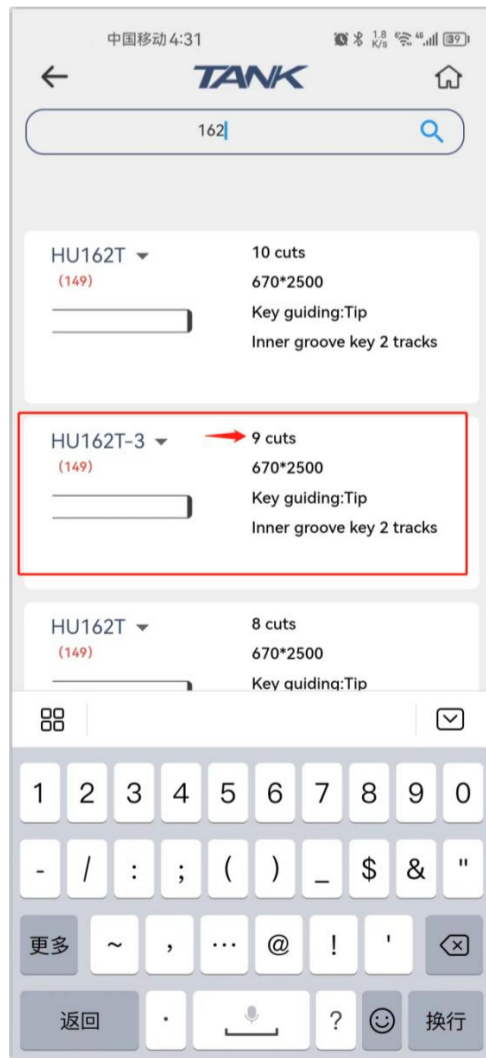
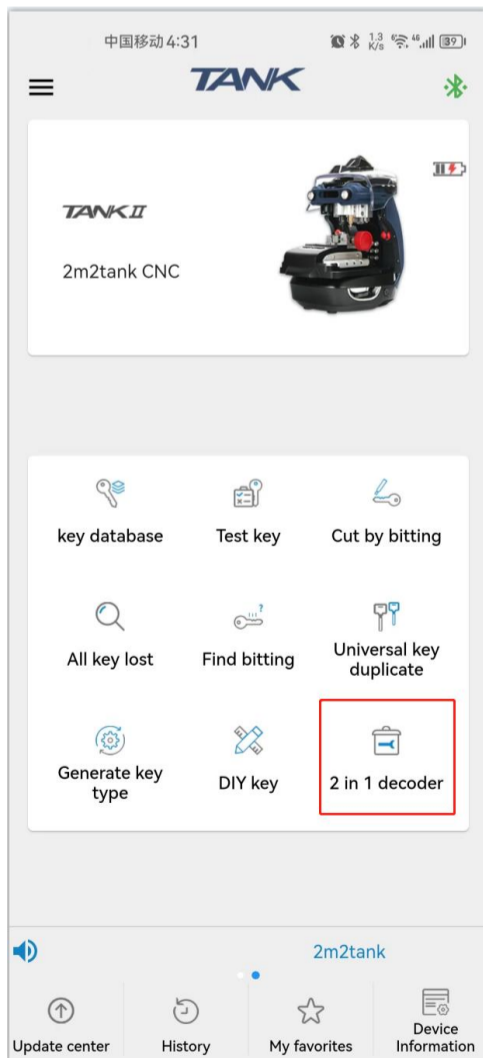

Click '2 in 1 decoder' --- 'HU162T-9 cuts'

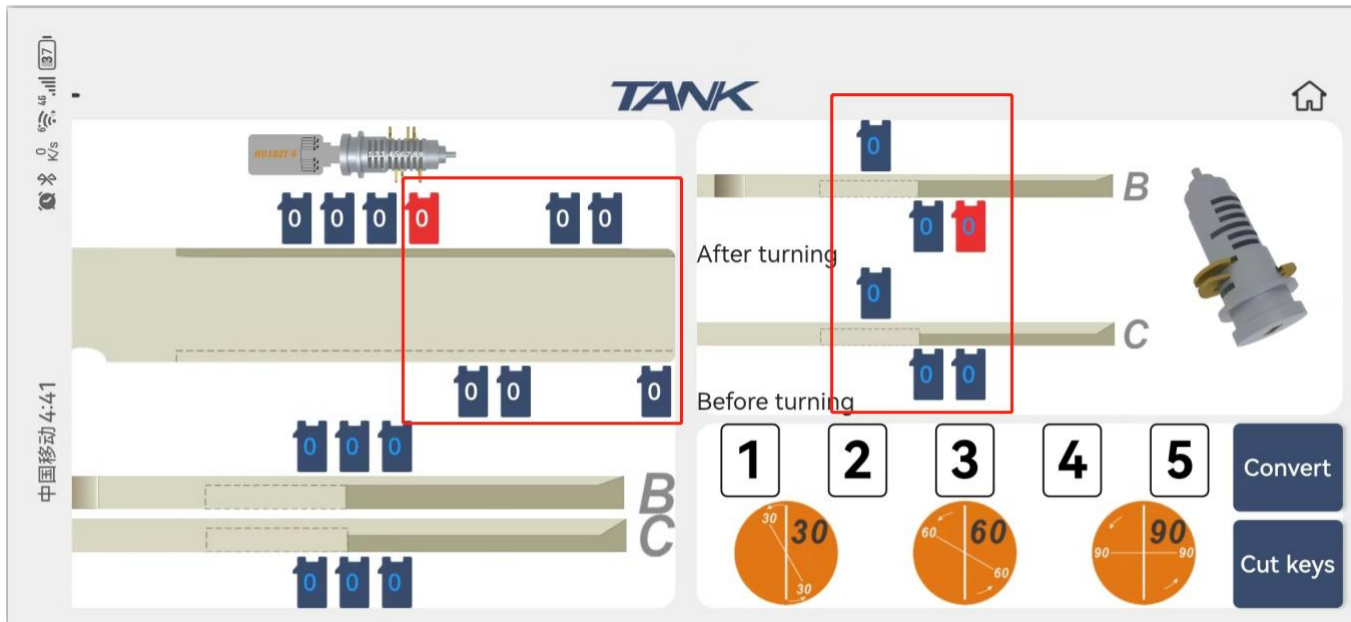

Input the key cuts that you decode via 2 in 1 decoder.

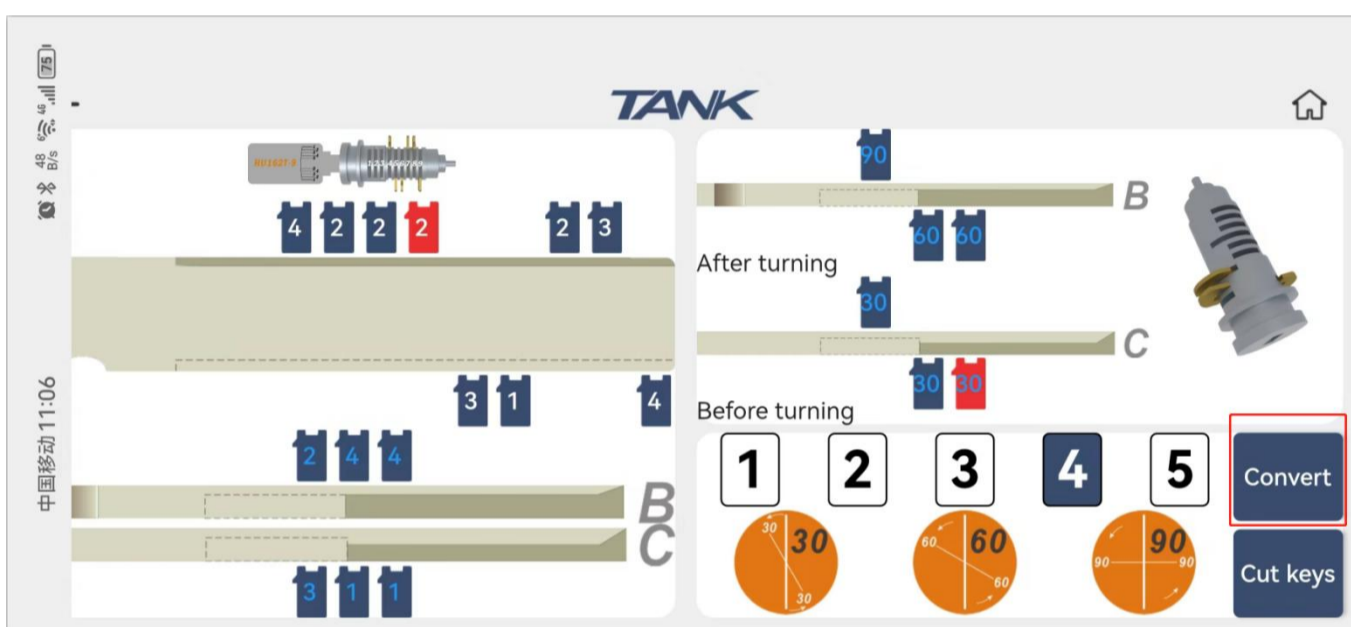

Please click 'convert'

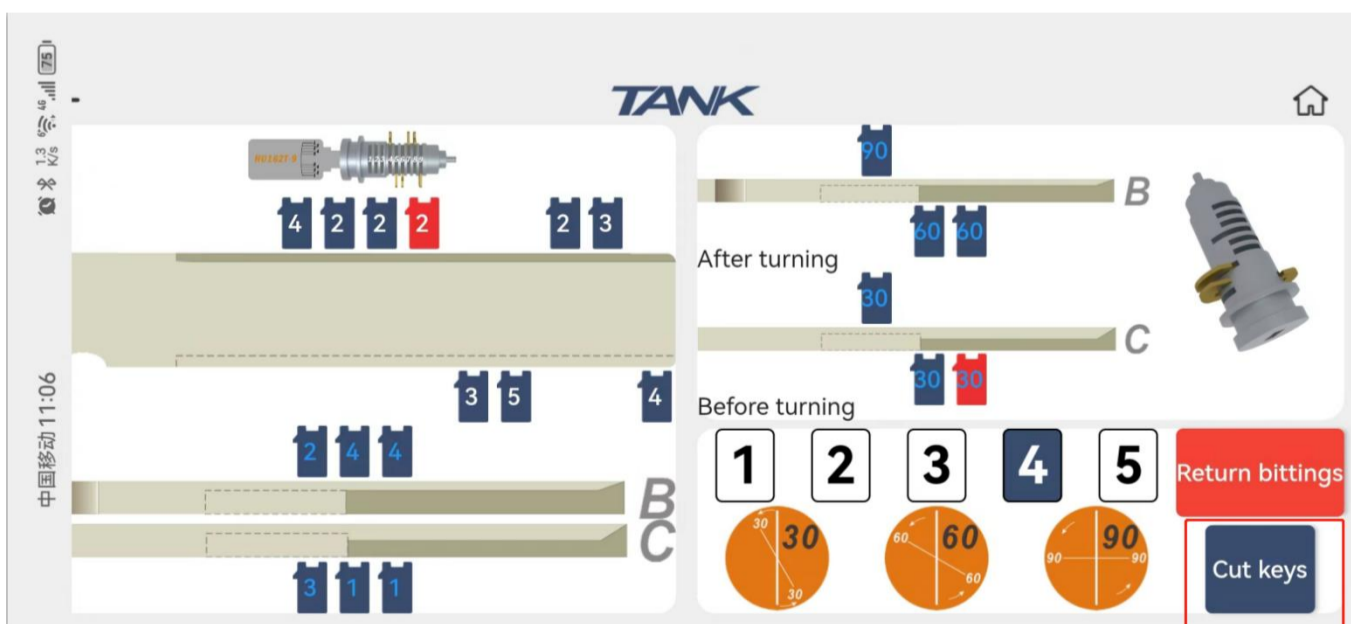

Click 'Cut key'

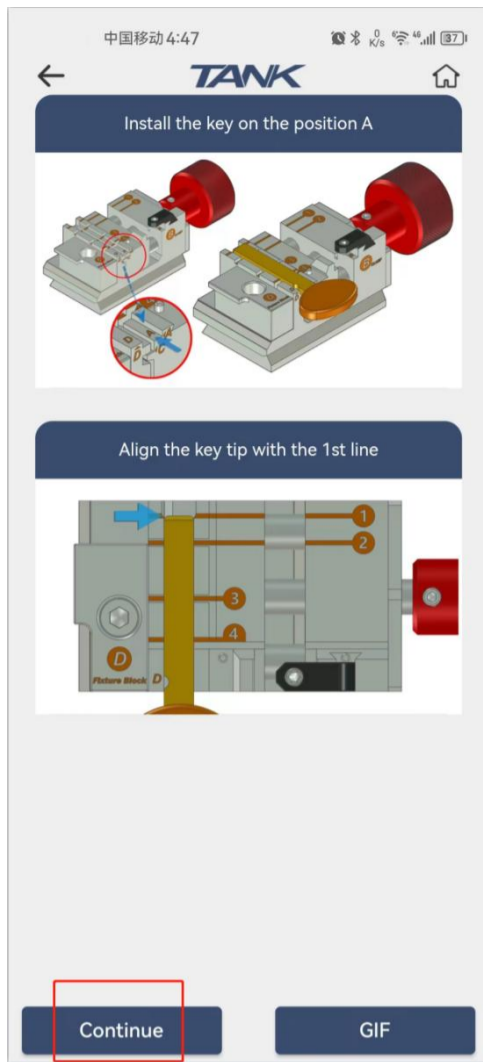

Click 'continue'

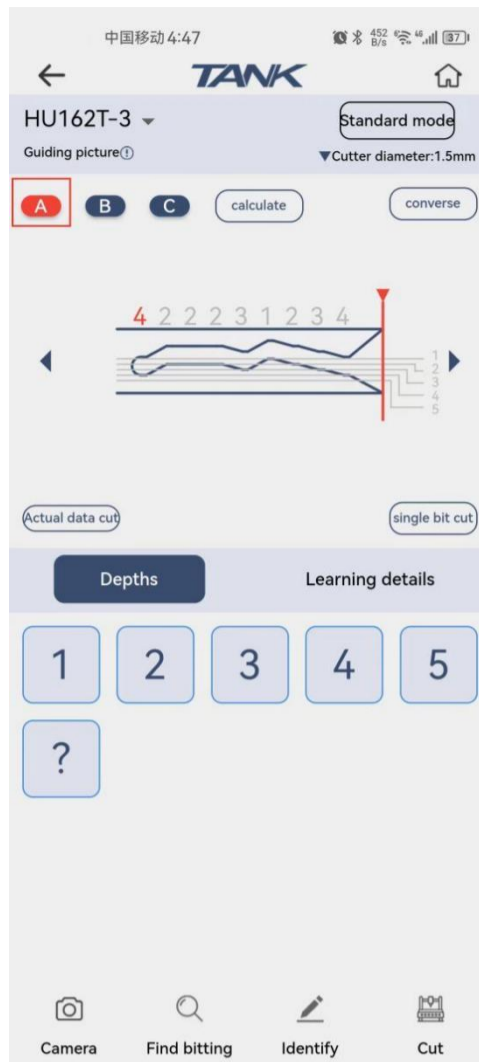

Click 'A'---' cut'

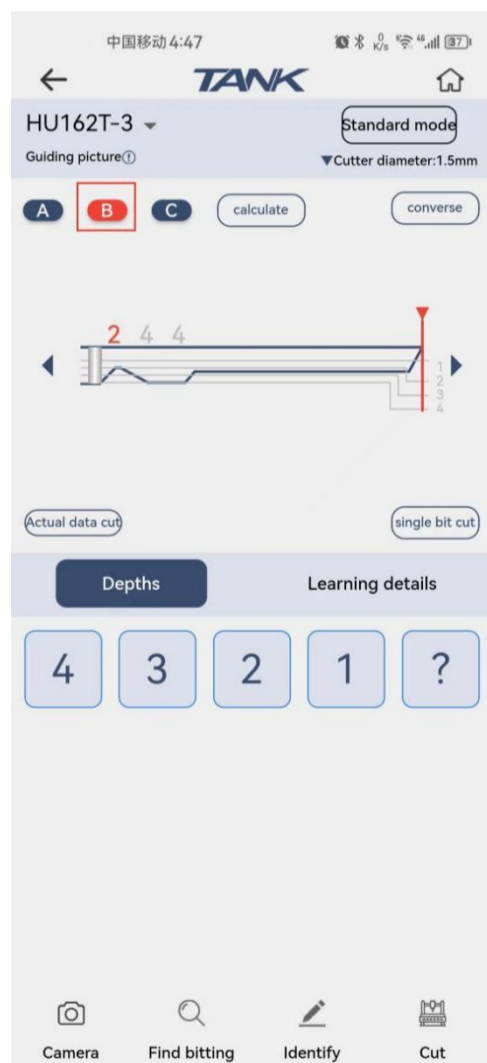

Click 'B'---' cut'

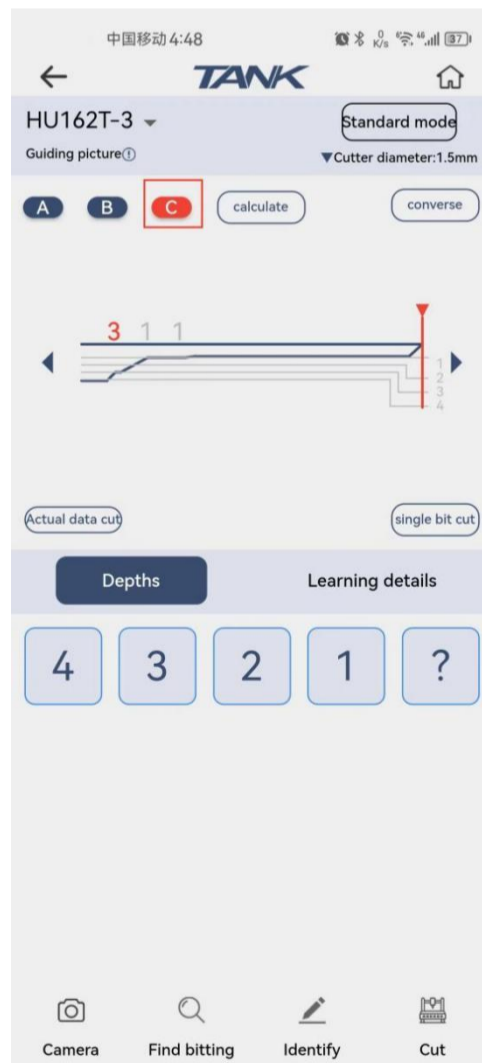

Click 'C'---' cut'

13-2 HU162T-10 cuts

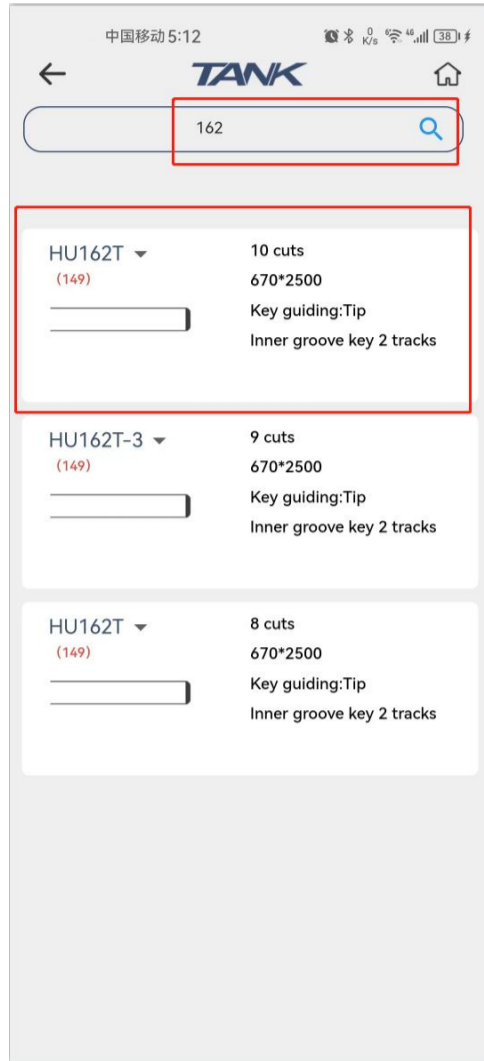
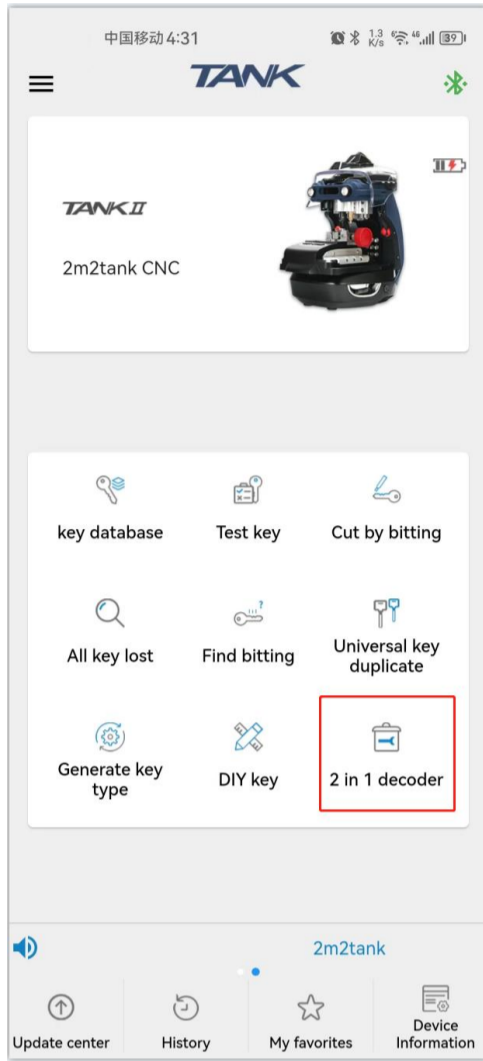

Click '2 in 1 decoder' --- 'HU162T-10 cuts'

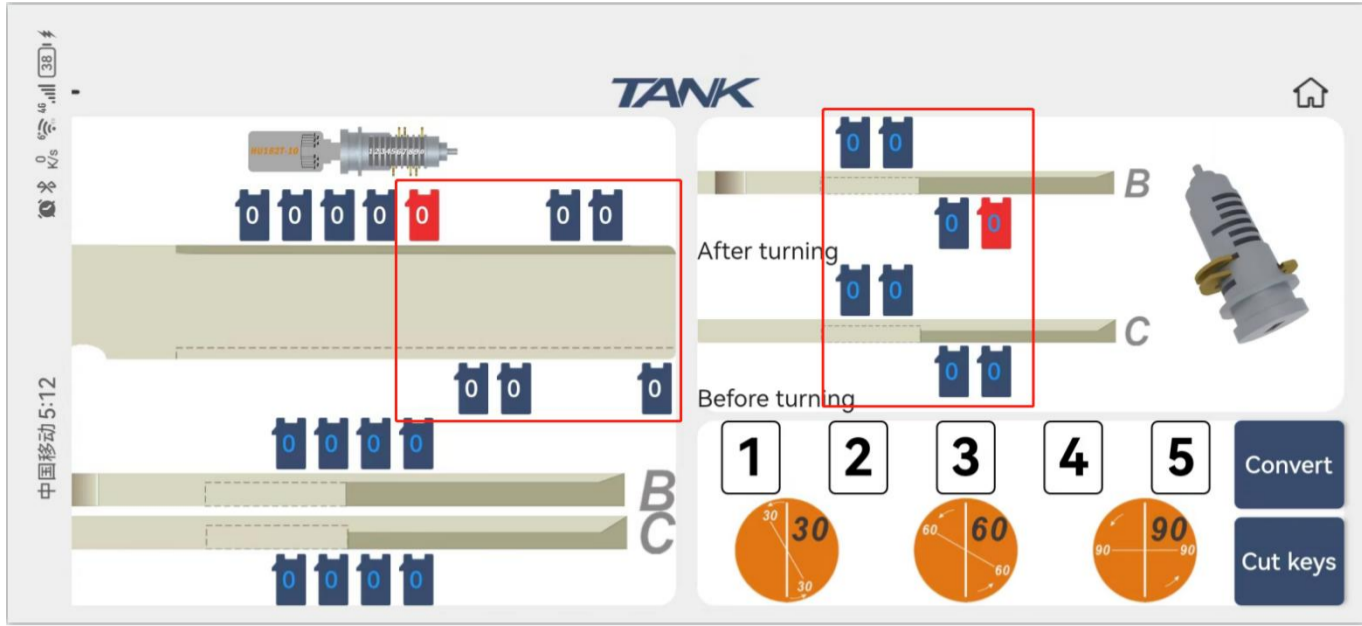

Input the key cuts that you decode via 2 in 1 decoder.

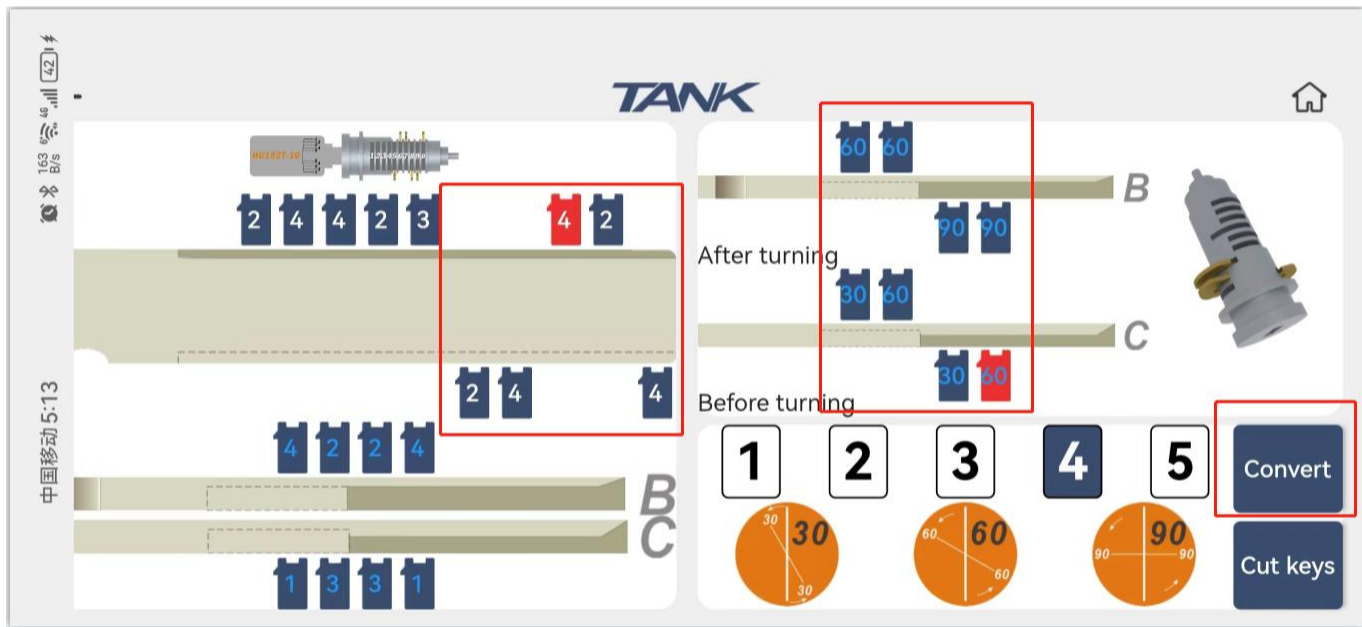

Click 'convert'

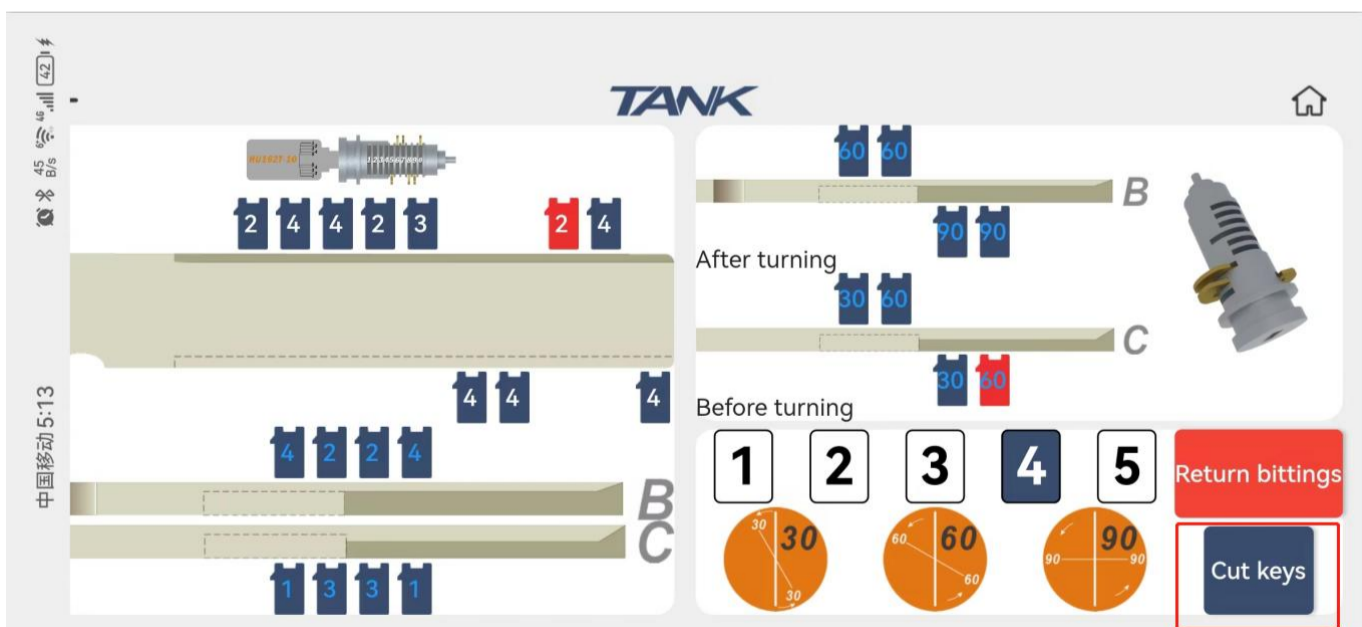

Click 'cut keys'

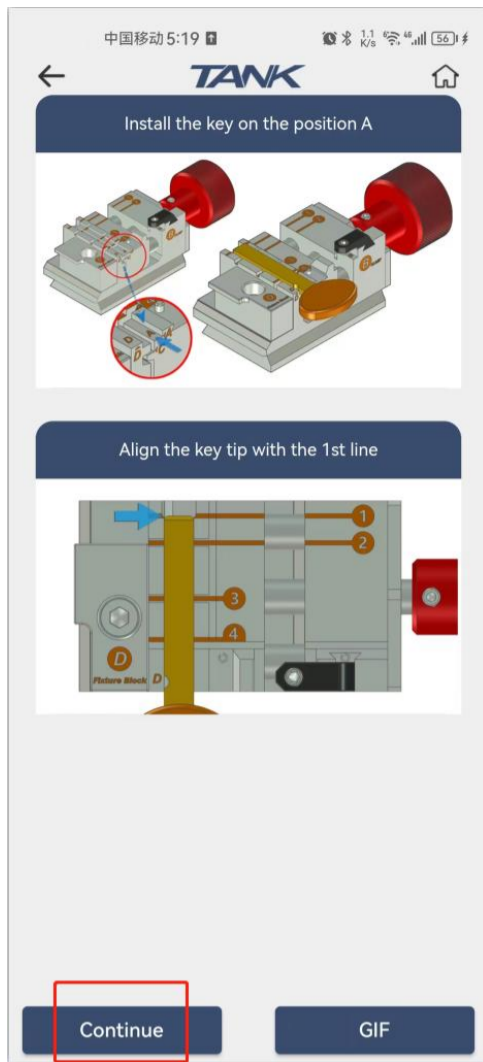

Click 'continue'

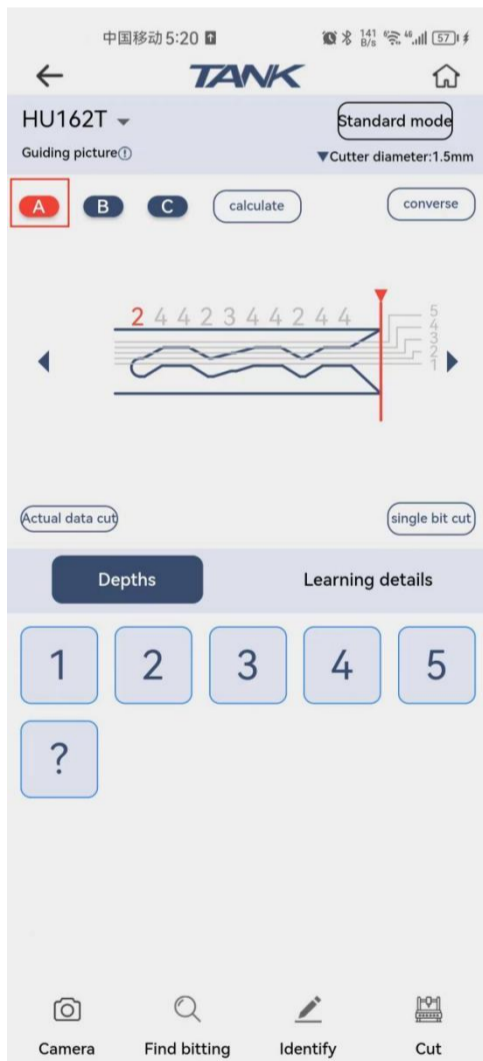

Click 'A' --- 'cut'

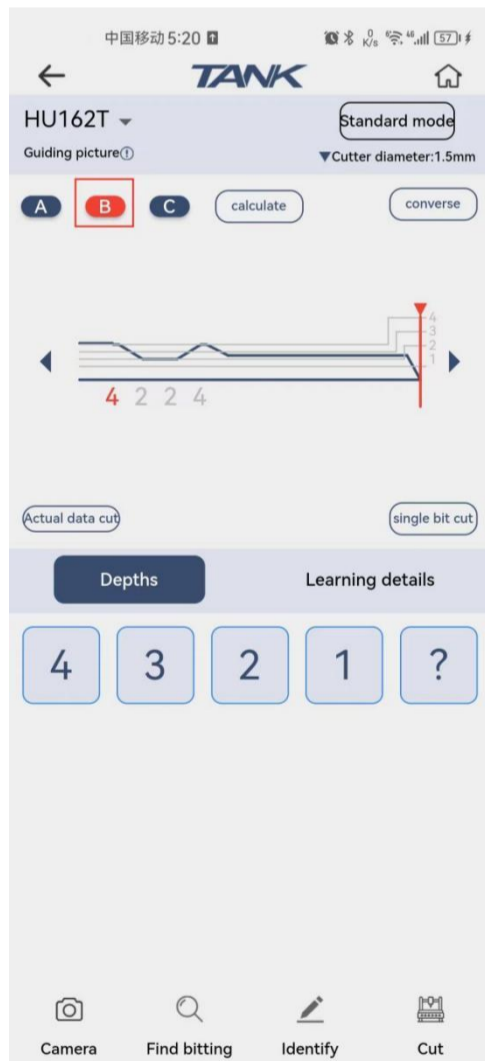

Click 'B' --- 'cut'

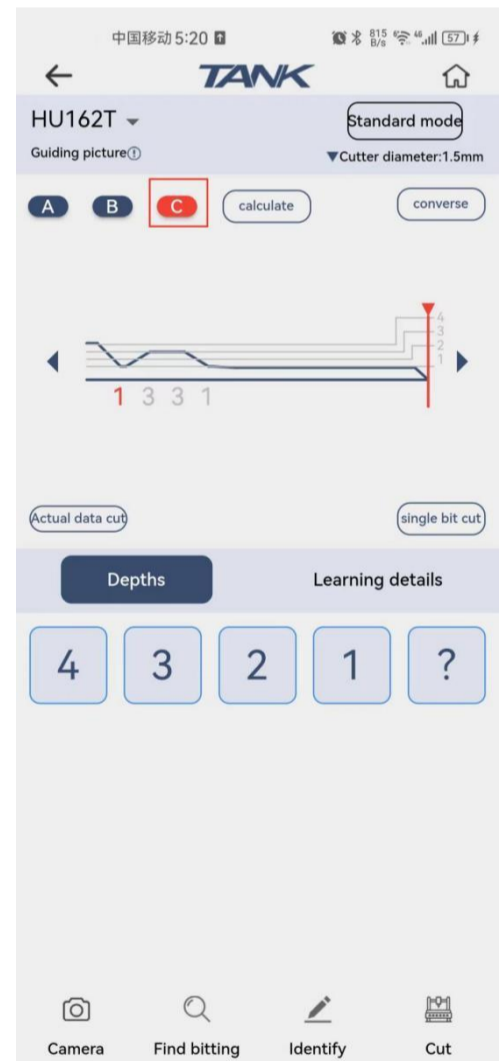

Click 'C' --- 'cut'

13-3 TOY43

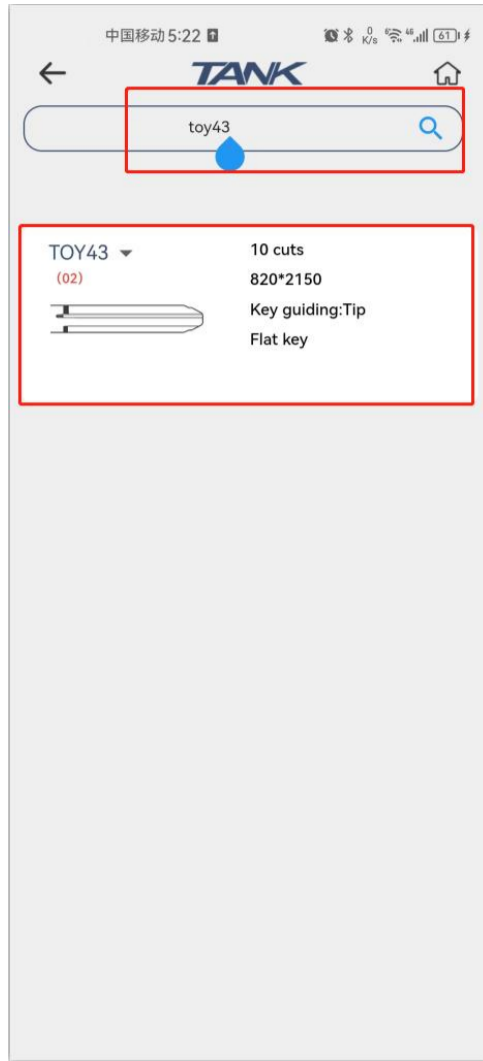
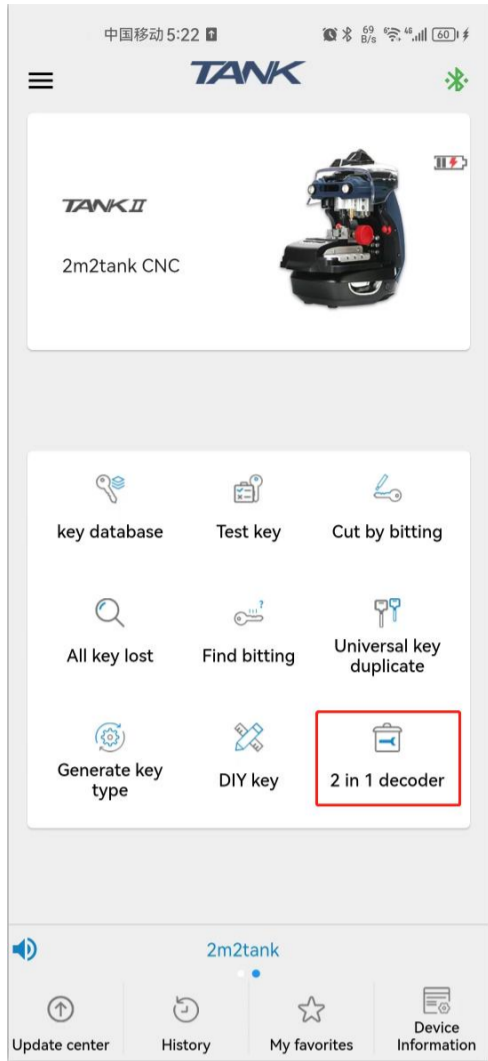

Click '2 in 1 decoder' --- 'TOY43'

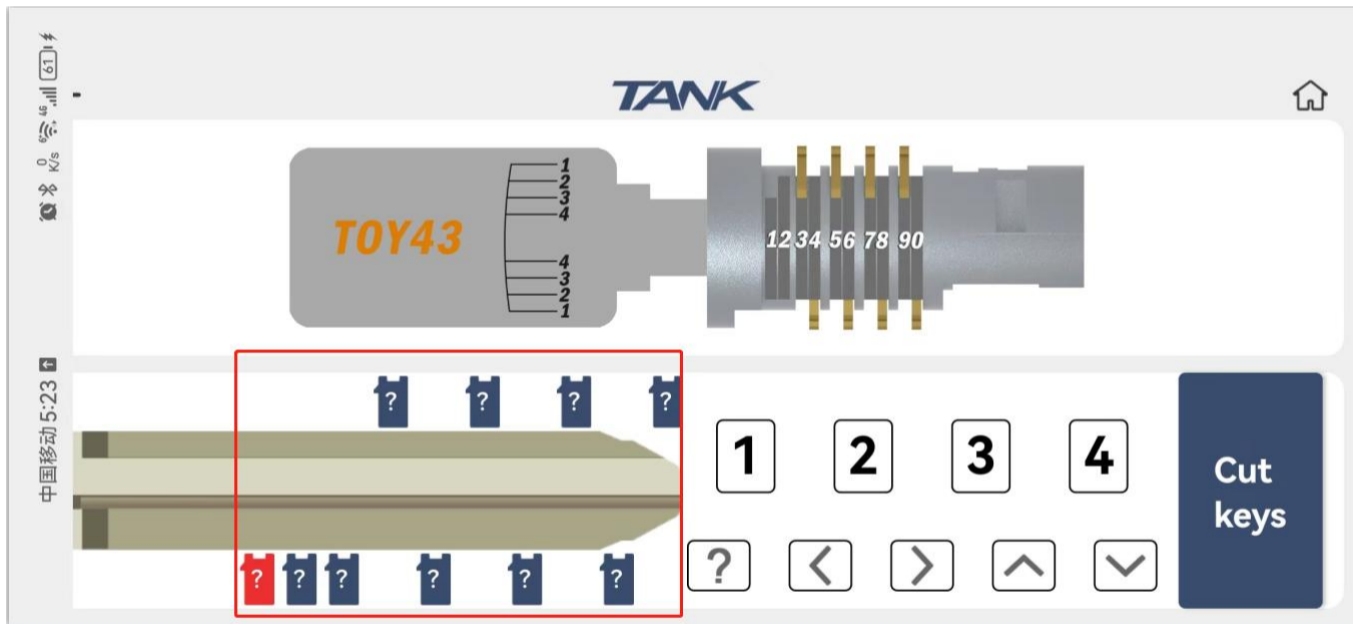

Please input the key cut that you decode by 2 in 1 decoder.

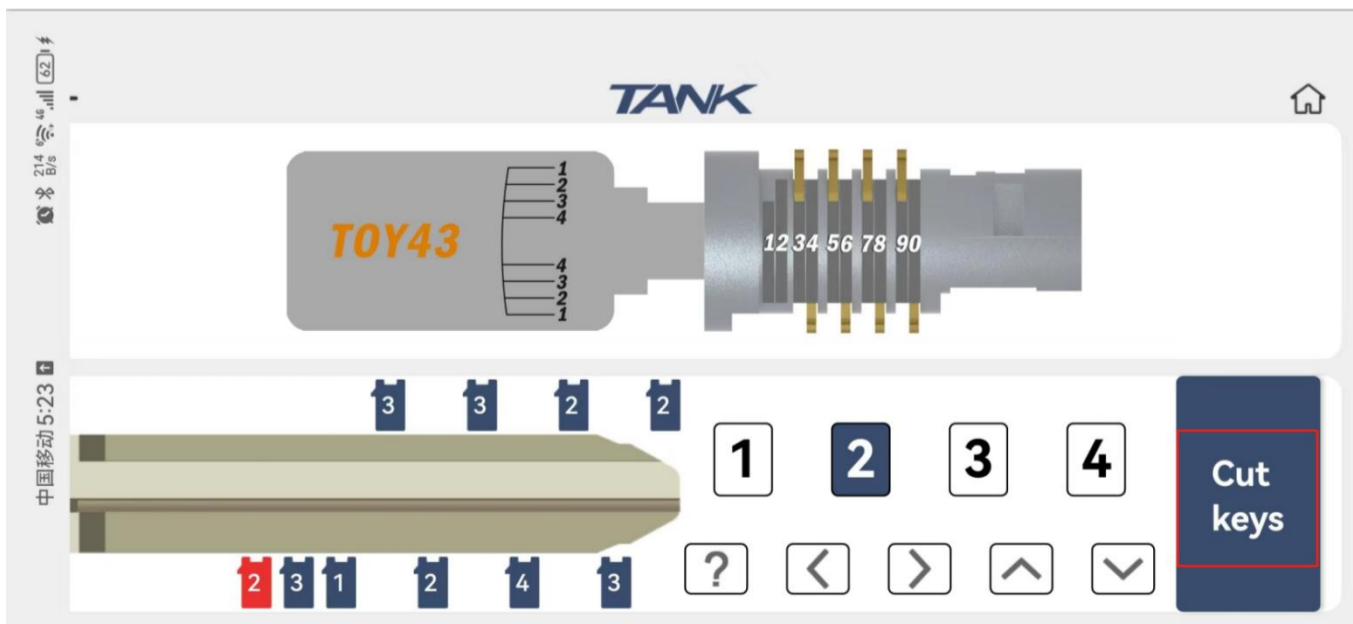

Click 'cut keys'

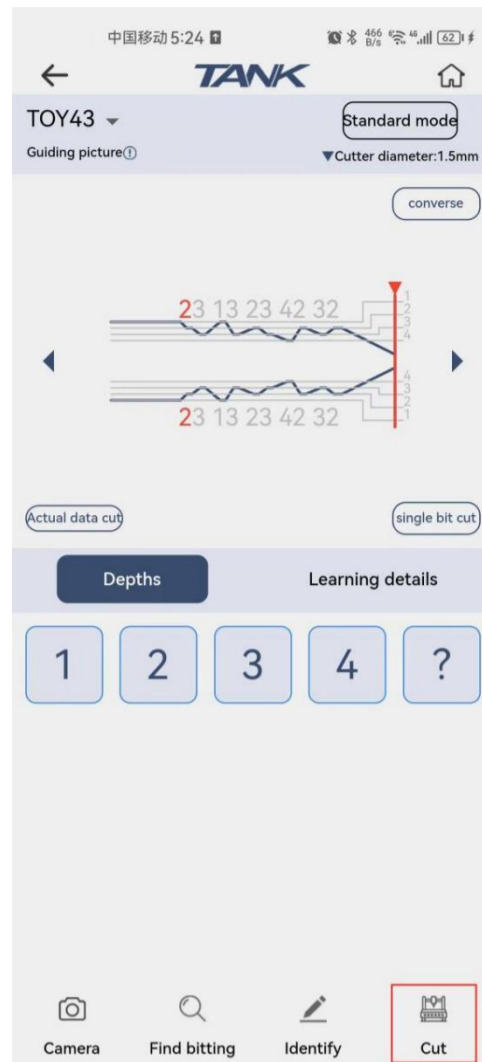
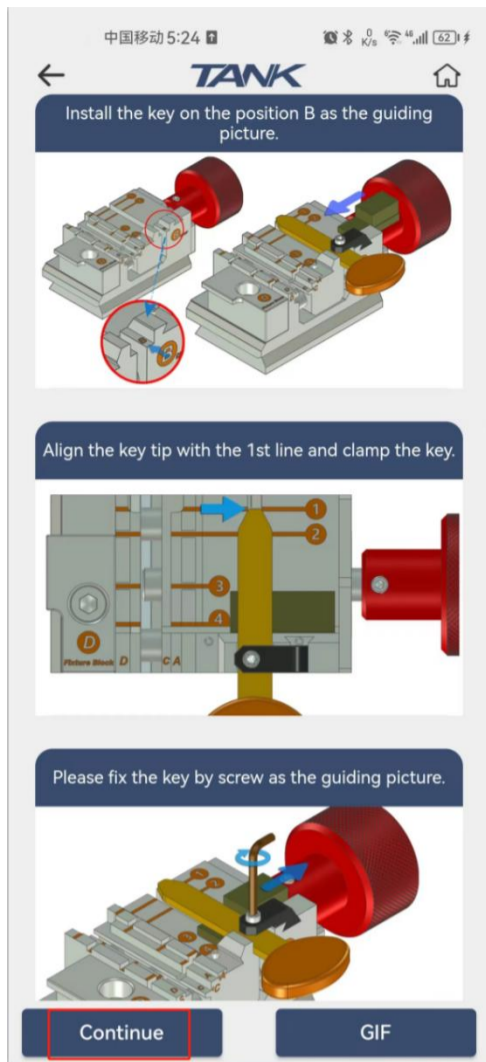

Click 'Continue' --- 'Cut'

14、Update

14-1 APP update

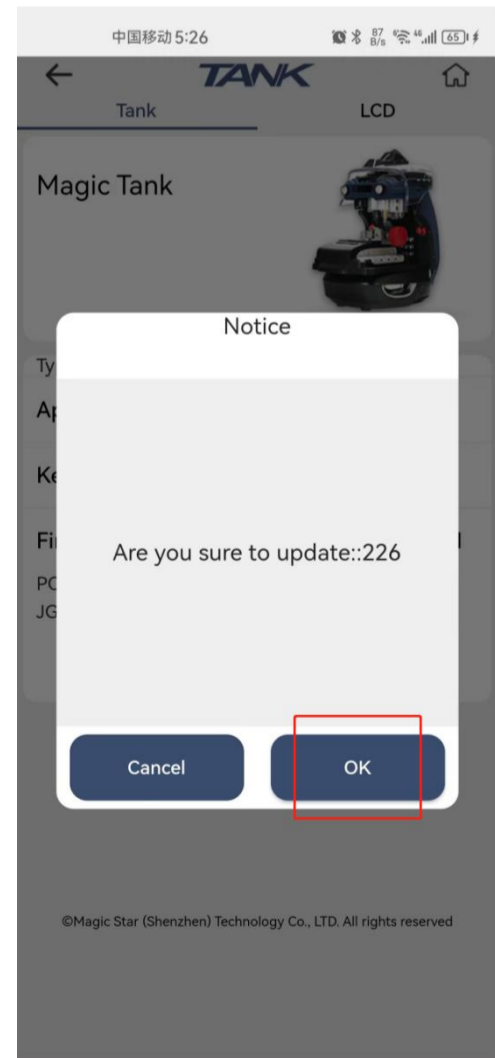
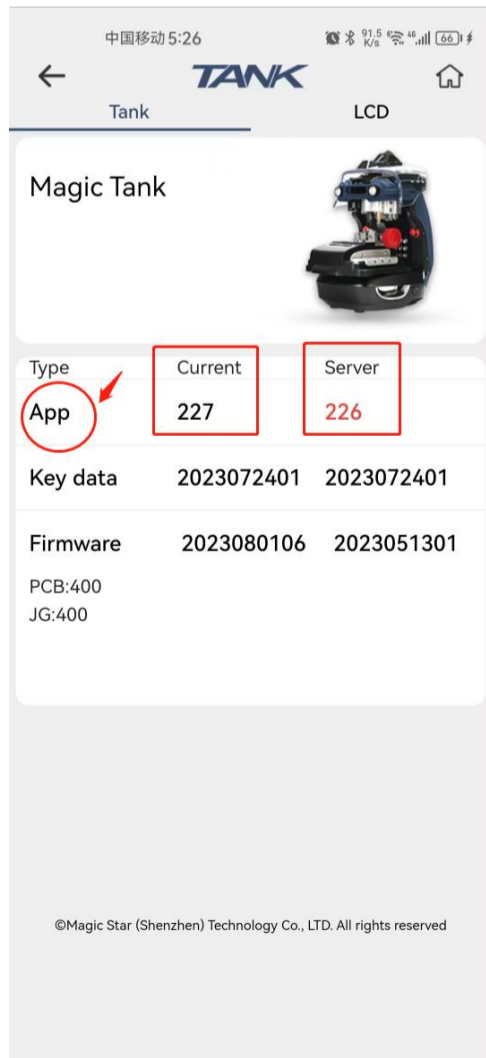
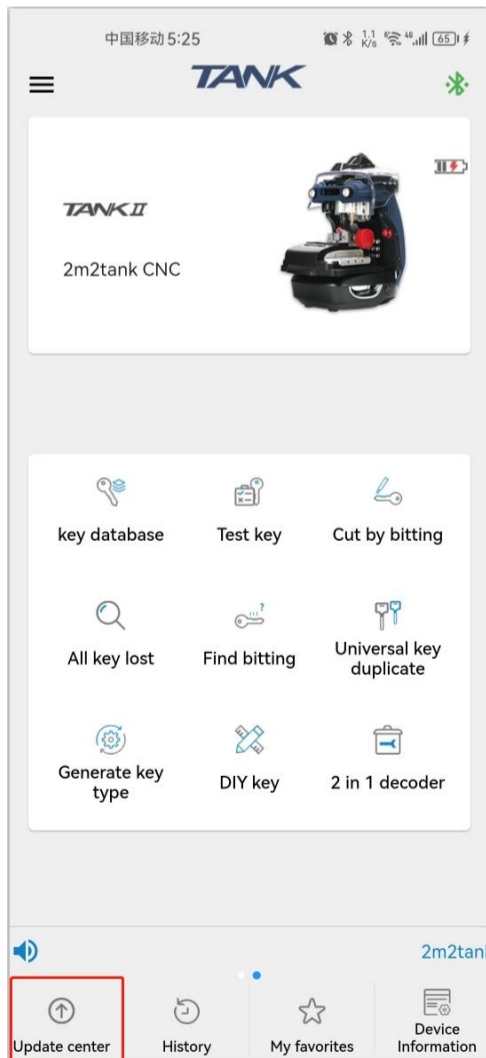

Click 'update center' --- Click version number that circled. --- Click 'ok'

14-2 Update key database

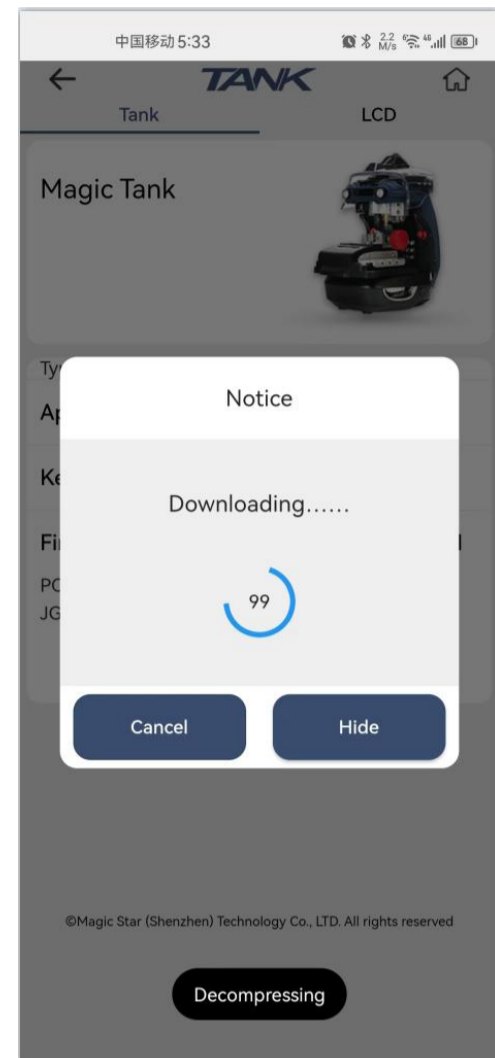
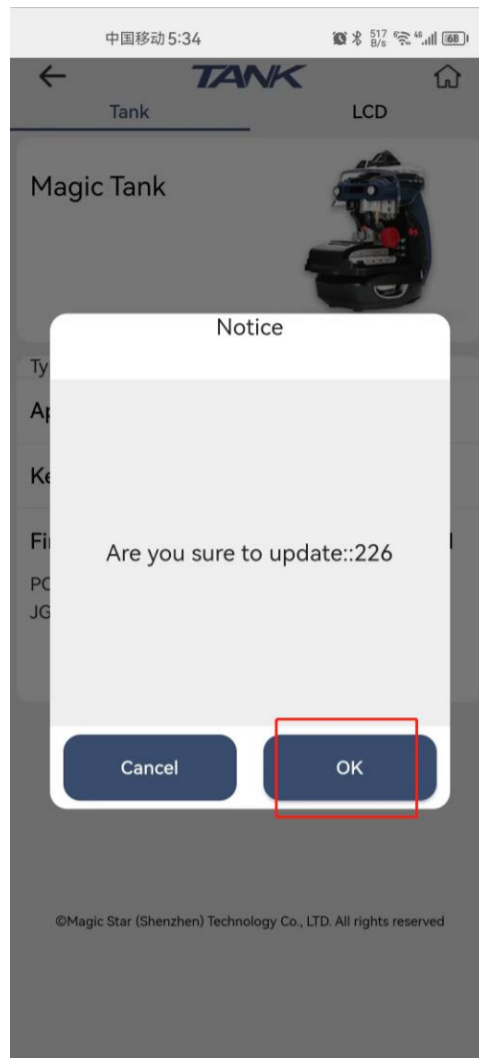
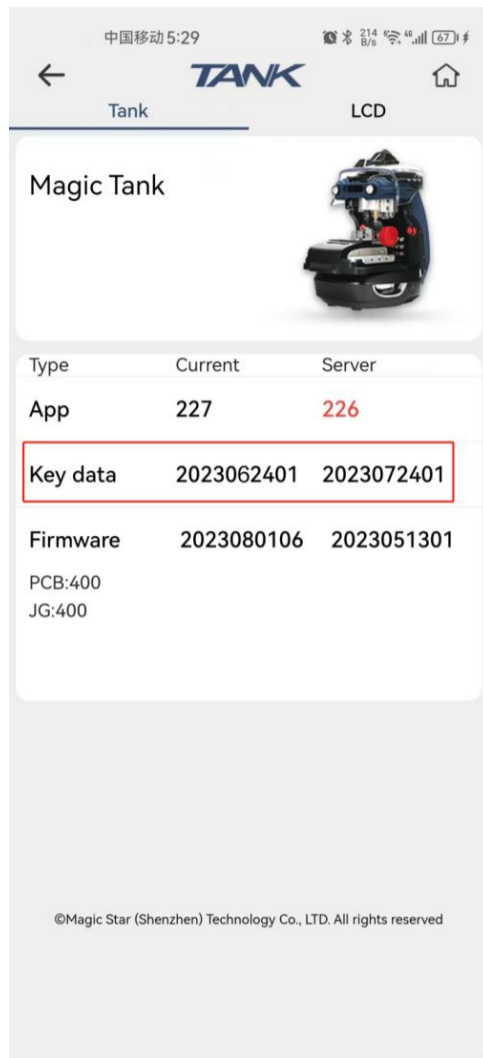

Click version number that circled and then click 'ok'.

14-3 Firmware update

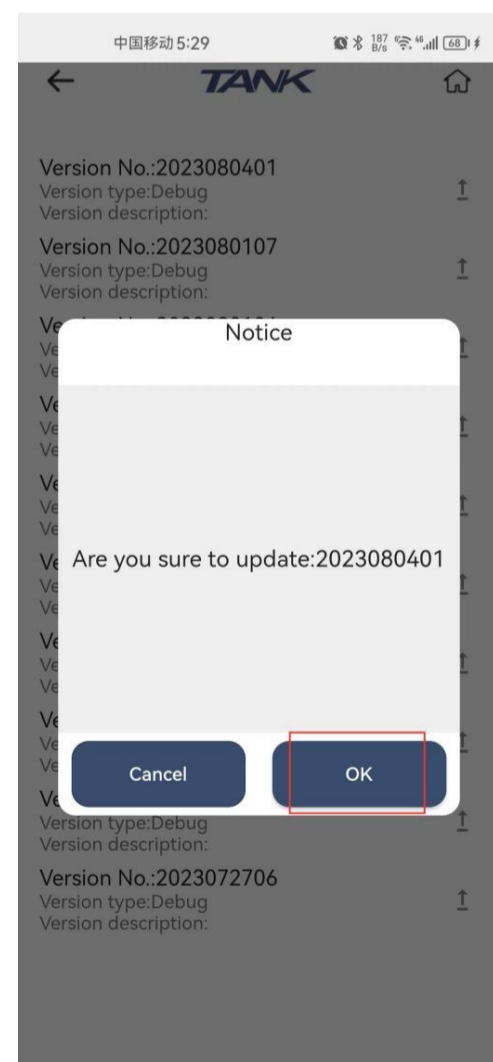
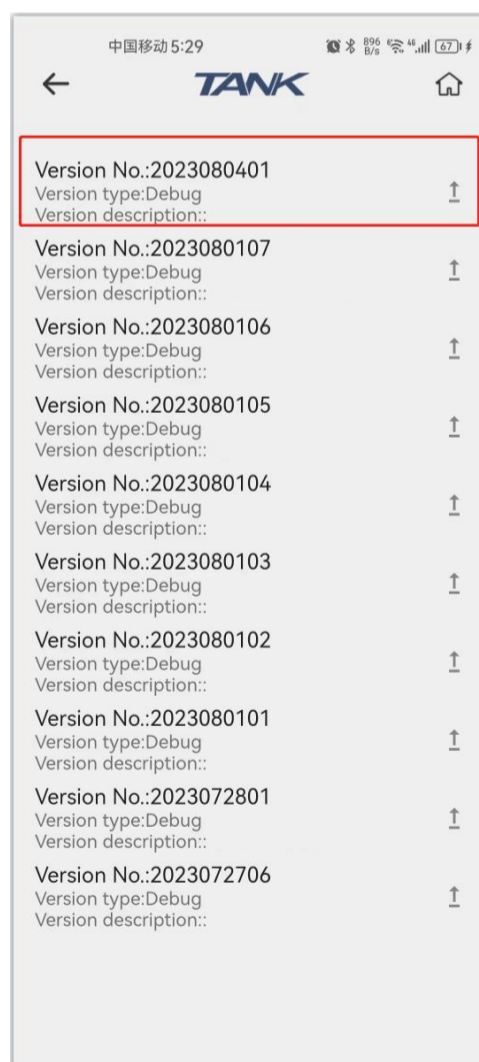
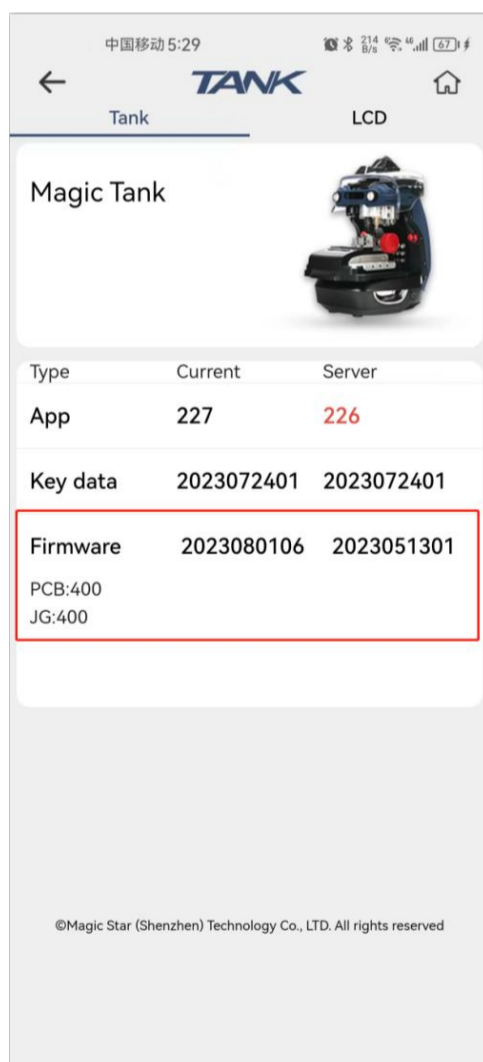

Click version number that circled and then click the first one for updating.

Click 'update log', and enter update information.

15、Maintenance

- Please clean the area around clamps with a brush before the machine starts to work. This is to assure cutting precision and avoid components damage by metal particles.
- To avoid damage or corrosion to the machine, please do not use detergent or other cleaning products to clean the machine.
- Please do not flush or wet the machine with water, in case rust and electrical current leakage.
- Under any circumstance, please do not try to clean the working area with air guns and drying machines, in case any metal carvings getting inside the machine.

16、Warranty

1. Warranty period from the activating day;
 - 2 years warranty (machine structure, screw ball, Main board and others);
 - 1 year warranty contains battery (optional) and power adapter.
2. becomes dysfunctional due to the following reasons:
 - Operation without referring to or violating the user manual
 - Modifications or repairs to the machine by individuals
 - Falling, knocking or wrong voltage
 - Force damage
 - If the machine or clamp scratches on the surface, it doesn't cover warranty range.



If you want to add your own key data, please contact us by WhatsApp .

Thanks for your reading, welcome to use 2M2 tank automatic key cutting machine.

.....END.....